

ENTSO-E HVDC Utilisation and Unavailability Statistics 2020

Publication Date: 24 June 2021

System Operations Committee



European Network of
Transmission System Operators
for Electricity

entsoe

ENTSO-E HVDC Utilisation and Unavailability Statistics 2020

Copyright © 2021 ENTSO-E AISBL

Report rendered 28 June 2021

Executive Summary

The HVDC links are important components for a stable operation of the Nordic and Baltic power system while supporting the commercial power trade in the European energy markets. Furthermore, the HVDC links can provide other important functions like voltage and emergency power support to the HVAC grid. Hence, the advantages of keeping the HVDC links in operation as much as possible are indisputable. The ENTSO-E HVDC Utilisation and Unavailability Statistics 2020 report aims to provide an overview of the Nordic and Baltic HVDC links as well as a detailed view of each individual link. The executive summary concludes the most important parts of the report into one chapter.

Overview

In 2020, 58.8 TWh of electric energy was transmitted through the Nordic and Baltic HVDC links, which is approximately 62 % of the total technical capacity (E_{max}) and correlates well with the percentage utilisation from previous years. Nevertheless, the transmitted energy and unavailable technical capacity is showing a slight increasing trend after a significant drop in 2012 and 2013, as seen in Figure ES.1.

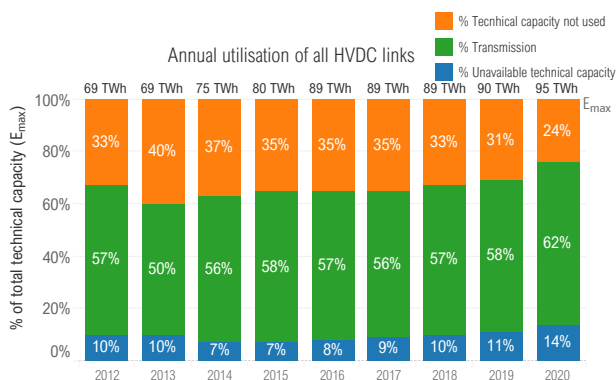

Figure ES.1: The annual utilisation of all HVDC links since 2012. Technical capacity not used is the amount of energy that has neither been transmitted nor been unavailable due to limitations or outages.

The total number of disturbance outages registered was 51, preventing 4.1 TWh of potential energy transmission, or 4.3 % of the total technical capacity (E_{max}). Maintenance outages amounted to 4.8 TWh, or 5.0 % of the total technical capacity (E_{max}), and limitations reduced the transmission capacity by 4.0 TWh (4.2 % of the total technical HVDC transmission capacity). The amount of unavailable technical capacity compared to the total technical capacity (E_{max}) has increased by approximately 1 % per year since 2015 and was in 2020 at its highest point since 2012, as can be seen from Figure ES.1. The increasing trend is visible in all unavailability categories except other outages. The unavailable technical capacity includes disturbance outages, limitations, unplanned and planned maintenance outages and other outages.

The most utilised electricity market connection was the one between Finland and Sweden (FI-SE3, HVDC links Fenno-Skan 1 and 2), with 85 % of the technical capacity being used for transmission, as shown in Table ES.1. No other market connection reached such a high utilisation percentage, and only seven of the thirteen market connections showed a utilisation percentage of more than 60 %. However, the utilisation percentage of all HVDC links in 2020 was still at its all-time highest value since 2012. The market connections with most unavailability were the ones between Denmark and Netherlands (DK1-NL, HVDC link COBRACable) and Denmark and Germany (DK2-DE, HVDC link Kontek), with 29 % and 30 % of the total capacity being unavailable due to outages and limitations, respectively.

Table ES.1: Annual utilisation rate of HVDC links per bidding zone.

	2012	2013	2014	2015	2016	2017	2018	2019	2020
DK1-DK2	45%	54%	58%	70%	78%	64%	63%	58%	71%
DK1-NL								80%	51%
DK2-DE	70%	70%	73%	75%	67%	66%	53%	69%	47%
FI-EE	59%	55%	41%	57%	42%	29%	37%	47%	75%
FI-SE3	54%	53%	76%	76%	78%	70%	72%	81%	85%
LT-PL					34%	47%	54%	61%	58%
NO2-DK1	68%	61%	55%	54%	61%	54%	53%	46%	62%
NO2-NL	89%	72%	90%	94%	72%	83%	68%	61%	77%
RU-FI	34%	36%	25%	29%	46%	50%	67%	61%	23%
SE3-DK1	56%	40%	49%	49%	59%	52%	53%	50%	57%
SE4-DE	60%	32%	47%	31%	43%	46%	33%	36%	55%
SE4-LT					44%	51%	50%	63%	76%
SE4-PL	52%	34%	61%	67%	56%	62%	66%	62%	72%
Grand Total	57%	50%	56%	58%	57%	56%	57%	58%	62%

The most significant unavailabilities in 2020 occurred for Baltic Cable, COBRACable, Kontek, Konti-Skan 2, NorNed and Skagerrak 1-4. Baltic Cable had 1 more severe disturbance outage, which was caused by a fault on the DC submarine cable, probably cut by an anchor of a boat, and lasted 29 days. The limitations on Baltic Cable were mainly due to maintenance in the AC grid. COBRACable's unavailability was mainly due to a disturbance outage caused by a submarine cable fault in September and lasted until 8 January 2021. Kontek had a fault on the land cable on the German side, which resulted in 94 days of further unplanned maintenance shortly after the 18 day long annual maintenance in September. Konti-Skan 2 (and 1) limitations were mainly due to maintenances on the AC-grid on both the Danish and Swedish side. The disturbance outage on Konti-Skan 2 was due to a fault in the smoothing reactor.

NorNed's planned maintenance outages and limitations were due to AC filters problems in Holland. The limitations were also due to the AC filters. Both Skagerrak 1 and 2 had a long disturbance outage caused by a cable fault due to (different) ships. Skagerrak 4 had an additional planned maintenance outage from May to July to cut cable samples for tests

and investigations. Skagerrak 1, 2, 3 and 4 have been limited due to “careful operation” since the Skagerrak 4 cable faults in December 2019. In 2020, the north direction (DK1→NO2) was prioritised until March, after which the south direction (NO2→DK1) was prioritised. The effect of these incidents can be seen in Figure ES.2.

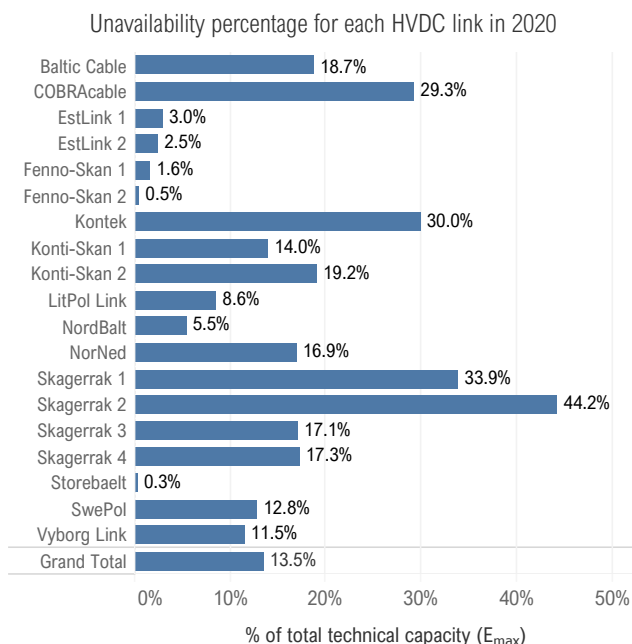

Figure ES.2: Percentage of unavailable technical capacity due to limitations, disturbance outages, unplanned and planned maintenance and other outages for each link in 2020.

Individual HVDC links

Baltic Cable

Baltic Cable had in 2020 its highest utilisation percentage of 55 % of the maximum technical capacity (E_{max}) since 2013. However, a fifth of the maximum technical capacity was unavailable. The unavailability was mainly due to one disturbance outage (DC submarine cable fault, probably cut by an anchor of a boat) and limitations due to maintenance in the AC grid. The amount of unavailable capacity due to limitations decreased from 24 % of the total technical capacity (E_{max}) in 2019 to 8 % in 2020.

COBRACable

COBRACable was commissioned in late 2019, thereby making the year 2020 its first fully operational year. The year started excellently with 89 % of the maximum technical (E_{max}) capacity being utilised in January. Unfortunately, a submarine cable fault in September took the link offline until 8 January 2021 and resulted in approximately 27 % of unavailable technical capacity.

EstLink 1 and 2

The use of EstLink 1 in 2020 has increased remarkably compared to previous years, with nearly 57 % of the maximum technical capacity (E_{max}) being transmitted between Finland and Estonia (FI–EE), and is close to the same level of trans-

mission as in 2012 when approximately 59 % of the technical capacity (E_{max}) was utilised. The remarkable increase also applies to EstLink 2, where 85 % of the technical capacity (E_{max}) was utilised as transmission. EstLink 2’s utilisation was the second highest of all HVDC links in this report in 2020, while at the same time reaching its all-time high value since its commissioning in 2014. The technical capacity not used was 40 % of the technical capacity (E_{max}) for EstLink 1 and 12 % for EstLink 2.

Unavailable technical capacity (E_U) due to outages and limitations reached approximately 3 % for both EstLink 1 and 2. Also, approximately 3 % of all operating hours were affected by outages or limitations for both EstLink 1 and EstLink 2, which means that nearly all of the outages and limitations reduced the transmission capacity by 100 % when they occurred.

Fenno-Skan 1 and 2

The use of Fenno-Skan 1 continued to be very high in 2020, with 97 % of the technical capacity (E_{max}) being utilised for transmission. On the other hand, the utilisation rate of Fenno-Skan 2 was 78 % of the maximum technical capacity (E_{max}) leaving approximately 21 % of the technical capacity unused (E_{TCNU}). The technical capacity not used (E_{TCNU}) of Fenno-Skan 2 increased slightly (by 1 percentage point) compared to 2019 (20 %), but was still only approximately half of the respective values in 2017 (40 %) and 2018 (39 %). Fenno-Skan 1 was the most utilised HVDC link in 2020 in this report, and Fenno-Skan 2 was the third most utilised HVDC link.

Almost all of the transmitted energy of Fenno-Skan 1 and 2 was transmitted from Sweden to Finland (SE3→FI) via Fenno-Skan 1 and 2. Both links had 4 planned maintenance outages each, and Fenno-Skan 1 had 3 minor disturbance outages. The average number of outages since 2017 is lower than the corresponding value for 2012–2016. Totally, below 1 % of the maximum technical capacity was unavailable (E_U) due to outages and limitations in 2020.

Kontek

After a good year in 2019, when Kontek had an available technical capacity (E_A) of 97 % and transmitted (E_T) approximately 69 % of its maximum technical capacity (E_{max}), 2020 did not meet expectations as the unavailable technical capacity (E_U) reached an all-time high of 30 % of the maximum technical capacity since 2012.

Everything looked good until after the annual maintenance in September, after which an unfortunate land cable fault on the German side resulted in 94 days of further unplanned maintenance. 2020 is not the first time Kontek has had cable faults resulting in a significant amount of unavailable technical capacity. In 2017, a cable fault resulted in approximately 12 % of the maximum technical capacity being unavailable, and in 2018 a land cable oil leak caused approximately 23 % of unavailable capacity.

Konti-Skan 1 and 2

The combined utilisation of Konti-Skan 1 and 2 (SE3–DK1) was 57 % of the total technical capacity (E_{\max}), which is an increase by 7 percentage points compared to 2019. The utilisation rate of the links in 2020 is at its highest since 2016.

Konti-Skan 1 and 2 have been utilised equally during the years since 2012, with the only exceptions being disturbance and maintenance outages that affect only the other link. The exception in 2020 was a 20-day disturbance outage on Konti-Skan 2 due to a fault in the smoothing reactor. The incident resulted in 5.6 % of Konti-Skan 2's technical capacity being unavailable, which also roughly equals the difference between the utilisation percentages of the links.

The percentage of hours affected by a limitation is remarkably high for Konti-Skan 1 and 2, with 33 % of all hours being at least partially limited in 2020 for Konti-Skan 1 and 30 % for Konti-Skan 2. A high percentage of hours affected, along with a low percentage of limited technical capacity (E_{Lim}), means that the limitations put into effect are of small magnitude.

LitPol Link

2020 was the first year since 2016, when LitPol Link's utilisation percentage did not increase, instead decreasing from 61 % of the maximum technical capacity (E_{\max}) in 2019 to 58 % in 2020. Additionally, the unavailable technical capacity (E_U) has increased from 4 % in 2019 to 9 % in 2020. The increase is due to a longer annual maintenance compared to previous years, which lasted 23 days starting from late September.

The percentage of hours affected by a limitation is remarkably high for LitPol Link, with 39 % of all hours being at least partially limited in 2020. A high percentage of hours affected, along with a low percentage of limited technical capacity (E_{Lim}), means that the limitations put into effect are of small magnitude.

NordBalt

NordBalt had yet again its best year of transmission since 2016, with 75 % of the technical capacity (E_{\max}) being transmitted between Sweden and Lithuania (SE4–LT). Furthermore, outages and limitations caused an all-time low of unavailable technical capacity since 2016, being about 5 % of the technical capacity (E_{\max}) in 2020. As a result, also the technical capacity not used (E_{TCNU}) reached an all-time low of 18 %, while it usually is around 30 %.

NorNed

The utilisation (E_T) of NorNed during 2020 was approximately 77 % of the maximum technical capacity (E_{\max}). The technical capacity not used was 6 % of the maximum technical capacity, which is an all-time low since 2015. However, the only thing stopping NorNed reaching its full potential was limitations due AC filter problems in Netherlands. The filter problems resulted in 16 % of the technical capacity being limited and therefore unavailable for transmission.

The percentage of hours affected by a limitation is remarkably high for NorNed, with 39 % of all hours being at least partially limited in 2020. A high percentage of hours affected, along with a low percentage of limited technical capacity (E_{Lim}), means that the limitations are lower than the rated capacity of the HVDC link.

Skagerrak 1, 2, 3 and 4

Skagerrak 1, 2, 3 and 4 have had a notable part of their transmission capabilities reduced by disturbance outages, planned maintenance outages and limitations since 2017, and 2020 was no exception. In 2020, Skagerrak 1 had 1 major disturbance outage caused by a cable fault due to a ship and lasted 88 days. Skagerrak 2 also had 1 major disturbance outage also caused by a cable fault due to a ship and lasted 123 days. While Skagerrak 3 and 4 had no major disturbance outages, Skagerrak 4 did have an additional planned maintenance outage from May to July to cut cable samples for tests and investigations. The limitations on Skagerrak 1, 2, 3 and 4 were mainly due to maintenances and restrictions on the maximum allowed electrode currents, which were put in place because of the Skagerrak 4 cable faults in 2019. The condition of the Skagerrak cables should be monitored in the future.

Storebaelt

Storebaelt available capacity is continuing to be high at approximately 99.7 % of the technical capacity (E_{\max}), which is also the highest of all HVDC links in this report in 2020. However, its utilisation percentage is showing a slight decrease since 2016, when it was 77 % of the technical capacity. In 2020, 71 % of the technical capacity was transmitted through the link.

SwePol

SwePol transmitted 72 % of its technical capacity (E_{\max}), which is approximately 10 percentage points more than in 2019 and also an all-time high since 2012. The available capacity was lower than normally due to one 19-day long disturbance outage and planned limitations originating from the AC grid. The disturbance outage was caused by a fire in the AC-filter on the Polish side in January.

Vyborg Link

The annual utilisation of Vyborg Link decreased from 61 % of the total technical capacity (E_{\max}) in 2019 to 23 % in 2020, which is also the lowest utilisation percentage since 2012. The utilisation of Vyborg Link is highly market dependent, with the Nordic and Russian market prices determining whether it or other HVDC links are used to transmit electricity to Finland.

Vyborg Link planned maintenances where mainly annual maintenances, which lasted 31 days in July and 44 days during August–September. Normally, maintenance work on Vyborg Link causes only limitations because the 350 MW units are not worked on simultaneously.

Table of Contents

Executive Summary	i	5.3.9 Konti-Skan 2	31
Overview	i	5.3.10 LitPol Link	33
Individual HVDC links	ii	5.3.11 NordBalt	35
Table of Contents	iv	5.3.12 NorNed	37
List of Figures	v	5.3.13 Skagerrak 1	39
List of Tables	vii	5.3.14 Skagerrak 2	41
1 Introduction and background	1	5.3.15 Skagerrak 3	43
2 Scope	2	5.3.16 Skagerrak 4	45
2.1 Contact persons	2	5.3.17 Storebaelt	47
3 Methods, definitions and calculations	3	5.3.18 SwePol	49
4 Technical details of the HVDC links	4	5.3.19 Vyborg Link	51
5 Results	6	References	54
5.1 Overview of 2020	6	Appendices	55
5.2 Overview of years 2012–2020	10	A Schematic presentation of HVDC links	56
5.3 Individual presentations of each HVDC link	14	B DISTAC origin of event classification	57
5.3.1 Baltic Cable	15	C Contact persons	58
5.3.2 COBRACable	17	D Sorted overview of utilisation and unavailability for all HVDC links	59
5.3.3 EstLink 1	19	E Additional figures	61
5.3.4 EstLink 2	21	E.1 Annual utilisation per type of HVDC converter	61
5.3.5 Fenno-Skan 1	23	E.2 Additional figures with percentages of hours unavailable	62
5.3.6 Fenno-Skan 2	25	E.3 Additional figures with origin of event	65
5.3.7 Kontek	27		
5.3.8 Konti-Skan 1	29		

List of Figures

ES.1 Annual utilisation of all HVDC links in percentages	i	5.29 Annual utilisation of Fenno-Skan 2	26
ES.2 Percentage distribution of unavailable technical capacity for each HVDC link in 2020	ii	5.30 Annual percentage of unavailability hours for Fenno-Skan 2	26
1.1 Map of HVDC links in this report	1	5.31 Annual number of outages for Fenno-Skan 2	26
3.1 The hierarchy of the availability and utilisation categories used in the HVDC statistics	3	5.32 Kontek availability and utilisation monthly	27
5.1 Availability and utilisation overview of each HVDC link in 2020	7	5.33 Annual utilisation of Kontek	28
5.2 Availability and utilisation overview per bidding zone in 2020	8	5.34 Annual percentage of unavailability hours for Kontek	28
5.3 Percentage distribution of unavailable technical capacity for each HVDC link in 2020	9	5.35 Annual number of outages for Kontek	28
5.4 The number of outages for each HVDC link in 2020.	9	5.36 Konti-Skan 1 availability and utilisation monthly	29
5.5 Annual utilisation percentage of all HVDC links	10	5.37 Annual utilisation of Konti-Skan 1	30
5.6 Annual utilisation of all HVDC links in terawatt hours	11	5.38 Annual percentage of unavailability hours for Konti-Skan 1	30
5.7 Percentage distribution of hours per utilisation rate	11	5.39 Annual number of outages for Konti-Skan 1	30
5.8 Annual distribution of unavailable technical capacity in percentages of the maximum technical capacity for all HVDC links	12	5.40 Konti-Skan 2 availability and utilisation monthly	31
5.9 Percentage of hours affected by limitations or outages for all HVDC links	12	5.41 Annual utilisation of Konti-Skan 2	32
5.10 Map of HVDC links in this report	14	5.42 Annual percentage of unavailability hours for Konti-Skan 2	32
5.11 Baltic Cable availability and utilisation monthly	15	5.43 Annual number of outages for Konti-Skan 2	32
5.12 Annual utilisation of Baltic Cable	16	5.44 LitPol Link availability and utilisation monthly	33
5.13 Annual percentage of unavailability hours for Baltic Cable	16	5.45 Annual utilisation of LitPol Link	34
5.14 Annual number of outages for Baltic Cable	16	5.46 Annual percentage of unavailability hours for LitPol Link	34
5.15 COBRACable availability and utilisation monthly	17	5.47 Annual number of outages for LitPol Link	34
5.16 EstLink 1 availability and utilisation monthly	19	5.48 NordBalt availability and utilisation monthly	35
5.17 Annual utilisation of EstLink 1	20	5.49 Annual utilisation of NordBalt	36
5.18 Annual percentage of unavailability for EstLink 1	20	5.50 Annual percentage of unavailability hours for NordBalt	36
5.19 Annual number of outages for EstLink 1	20	5.51 Annual number of outages for NordBalt	36
5.20 EstLink 2 availability and utilisation monthly	21	5.52 NorNed availability and utilisation monthly	37
5.21 Annual utilisation of EstLink 2	22	5.53 Annual utilisation of NorNed	38
5.22 Annual percentage of unavailability hours for EstLink 2	22	5.54 Annual percentage of unavailability hours for NorNed	38
5.23 Annual number of outages for EstLink 2	22	5.55 Annual number of outages for NorNed	38
5.24 Fenno-Skan 1 availability and utilisation monthly	23	5.56 Skagerrak 1 availability and utilisation monthly	39
5.25 Annual utilisation of Fenno-Skan 1	24	5.57 Annual utilisation of Skagerrak 1	40
5.26 Annual percentage of unavailability hours for Fenno-Skan 1	24	5.58 Annual percentage of unavailability hours for Skagerrak 1	40
5.27 Annual number of outages for Fenno-Skan 1	24	5.59 Annual number of outages for Skagerrak 1	40
5.28 Fenno-Skan 2 availability and utilisation monthly	25	5.60 Skagerrak 2 availability and utilisation monthly	41
		5.61 Annual utilisation of Skagerrak 2	42
		5.62 Annual percentage of unavailability hours for Skagerrak 2	42
		5.63 Annual number of outages for Skagerrak 2	42
		5.64 Skagerrak 3 availability and utilisation monthly	43
		5.65 Annual utilisation of Skagerrak 3	44
		5.66 Annual percentage of unavailability hours for Skagerrak 3	44
		5.67 Annual number of outages for Skagerrak 3	44
		5.68 Skagerrak 4 availability and utilisation monthly	45
		5.69 Annual utilisation of Skagerrak 4	46

5.70 Annual percentage of unavailability hours for Skagerrak 4	46	E.1 Annual utilisation of all LCC HVDC links	61
5.71 Annual number of outages for Skagerrak 4	46	E.2 Annual utilisation of all VSC HVDC links	61
5.72 Storebaelt availability and utilisation monthly	47	E.3 Percentage of hours limited due to seasonal causes	62
5.73 Annual utilisation of Storebaelt	48	E.4 Annual percentage of hours limited, grouped by limitation origin and type	62
5.74 Annual percentage of unavailability hours for Storebaelt	48	E.5 Percentage of hours each HVDC link has been limited, grouped by limitation origin and type	63
5.75 Annual number of outages for Storebaelt	48	E.6 Percentage of hours connection between each bidding zone has been limited, grouped by limitation origin and type	63
5.76 SwePol availability and utilisation monthly	49	E.7 Percentage of hours unavailable due to planned maintenance per primary cause per HVDC link in 2020 and the annual percentage for all HVDC links combined	64
5.77 Annual utilisation of SwePol	50	E.8 Average annual number of disturbance outages for all HVDC links, grouped by origin of event	65
5.78 Annual percentage of unavailability hours for SwePol	50	E.9 Annual unavailable capacity due to disturbances outages for all HVDC links, distributed by origin of event	65
5.79 Annual number of outages for SwePol	50	E.10 Annual unavailable capacity due to maintenance outages for all HVDC links, distributed by primary cause	67
5.80 Vyborg Link availability and utilisation monthly	51	E.11 Annual unavailable capacity due to corrective maintenance outages for all HVDC links, distributed by origin of event, and the annual average number of them.	67
5.81 Vyborg Link availability and utilisation monthly	52		
5.82 Annual utilisation of Vyborg Link	53		
5.83 Annual percentage of unavailability hours for Vyborg Link	53		
5.84 Annual number of outages for Vyborg Link	53		
A.1 A schematic presentation of a converter station of a LCC HVDC link	56		
A.2 A schematic presentation of a converter station of a VSC HVDC link	56		
D.1 Utilisation and unavailability for each HVDC link, sorted by unavailable technical capacity	59		
D.2 Utilisation and unavailability for each HVDC link, sorted by transmission	60		
D.3 Utilisation and unavailability for each HVDC link, sorted by technical capacity not used	60		

List of Tables

ES.1 Annual utilisation rate of all HVDC links per bidding zone	i	5.13 LitPol monthly distribution of technical capacity (E_{max})	33
4.1 Main properties of the HVDC links	4	5.14 NordBalt monthly distribution of technical capacity (E_{max})	35
4.2 Technical details of the HVDC links	5	5.15 NorNed monthly distribution of technical capacity (E_{max})	37
5.1 Annual utilisation percentage of HVDC links per bidding zone	13	5.16 Skagerrak 1 monthly distribution of technical capacity (E_{max})	39
5.2 Annual unavailability percentage of HVDC links per bidding zone	13	5.17 Skagerrak 2 monthly distribution of technical capacity (E_{max})	41
5.3 Annual technical capacity not used percentage of HVDC links per bidding zone	13	5.18 Skagerrak 3 monthly distribution of technical capacity (E_{max})	43
5.4 Baltic Cable monthly distribution of technical capacity (E_{max})	15	5.19 Skagerrak 4 monthly distribution of technical capacity (E_{max})	45
5.5 COBRACable monthly distribution of technical capacity (E_{max})	17	5.20 Storebaelt monthly distribution of technical capacity (E_{max})	47
5.6 EstLink 1 monthly distribution of technical capacity (E_{max})	19	5.21 SwePol monthly distribution of technical capacity (E_{max})	49
5.7 EstLink 2 monthly distribution of technical capacity (E_{max})	21	5.22 Vyborg Link monthly distribution of technical capacity (E_{max})	51
5.8 Fenno-Skan 1 monthly distribution of technical capacity (E_{max})	23	5.23 Vyborg Link monthly distribution of technical capacity (E_{max})	52
5.9 Fenno-Skan 2 monthly distribution of technical capacity (E_{max})	25	B.1 The origin of event categories and subcategories used in this report	57
5.10 Kontek monthly distribution of technical capacity (E_{max})	27	E.1 Annual unavailable capacity due to disturbances outages for all HVDC links, distributed by origin of event	66
5.11 Konti-Skan 1 monthly distribution of technical capacity (E_{max})	29		
5.12 Konti-Skan 2 monthly distribution of technical capacity (E_{max})	31		

1 Introduction and background

This report presents the availability and utilisation of HVDC links connected to the Nordic and Baltic power system in 2020, with an emphasis on disturbance outages. This includes an overview of availability and utilisation for the HVDC links, information about disturbances and unavailability and individual presentations of the performance of each HVDC link.

The first version of the HVDC statistics for utilisation and unavailability was published in 2011 as an addition to the Nordic Grid Disturbance and Fault Statistics 2010 [1]. At that time, the report covered only the Nordic power systems and

presented 8 HVDC links. For the statistical year 2020, the HVAC Grid Disturbance Report and HVDC statistics were separated into two reports, which is the format of the reports today. In present time, this report includes 19 HVDC links connected to the Nordic and Baltic countries.

The total HVDC transmission capacity connected to the Nordic and Baltic power systems in 2020 is 10.9 GW, which makes the annual transmission capacity 95.5 TWh. Most of the HVDC links connect the Nordic synchronous system to other systems. A map of the bidding zones and each HVDC link is presented in Figure 1.1.

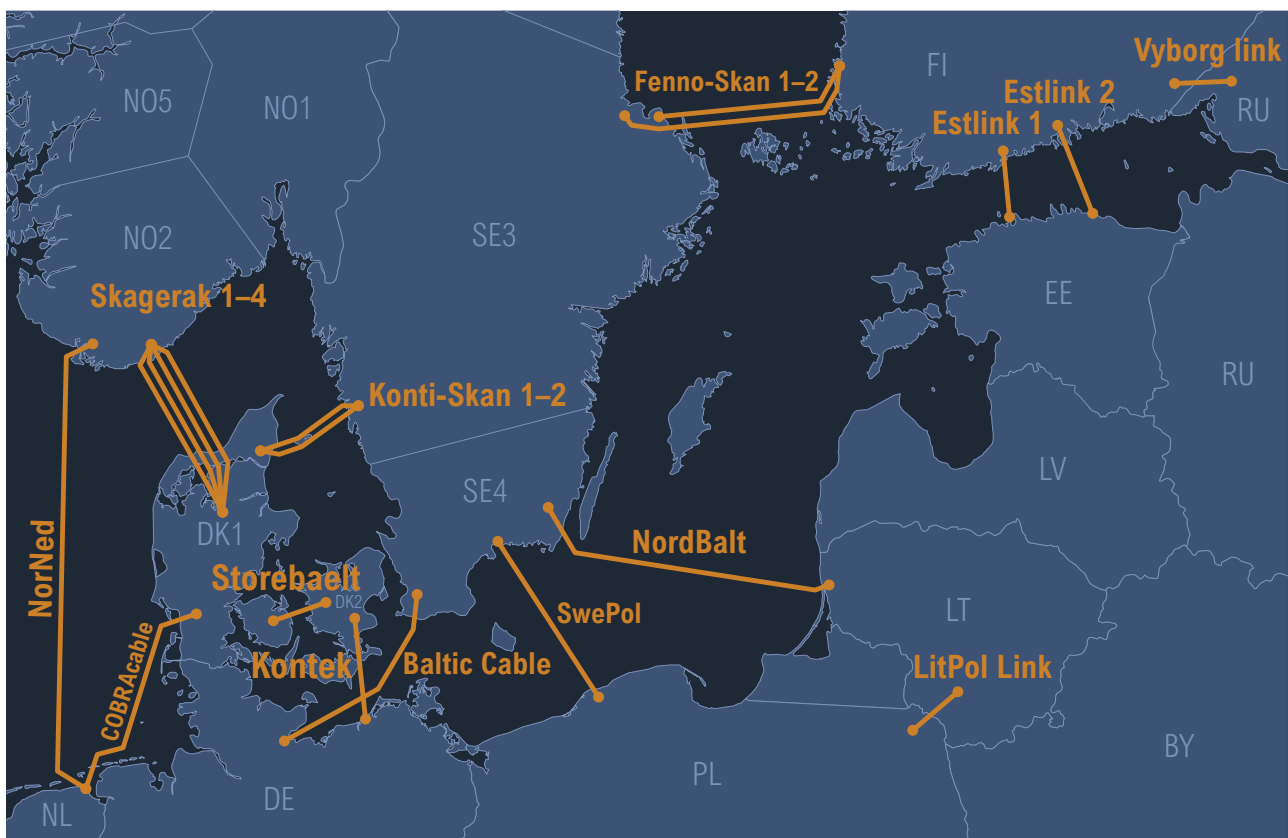

Figure 1.1: A map of the bidding zones and the 19 HVDC links included in this report.

The HVDC links are important components for a stable operation of the Nordic and Baltic power system while supporting the commercial power trade in the European energy markets. Furthermore, the HVDC links can provide other important functions like voltage and emergency power support to the HVAC grid. Hence, the advantages of keeping the HVDC links in operation as much as possible are indisputable.

To achieve as much uptime as possible, the number and length of disturbance outages must be kept at minimum. This requires high-quality hardware components, thorough

installation routines, and efficient fault analysis combined with preventive maintenance. However, planned outages and limitations due to maintenance work are necessary but should be planned and conducted as efficiently as possible.

Therefore, mapping the available capacity, including the reasons for unavailability, is of vital interest for the utilisation of this infrastructure. Furthermore, the utilisation of the links directly correlates with the commercial value of the energy trade.

2 Scope

The ENTSO-E HVDC Utilisation and Unavailability Statistics 2020 presents a macro view of the availability and utilisation of each HVDC link, including disturbance, maintenance and other outage events as well as limitations. Limitations originating from maintenance work done in the AC grid are also included if they affect the power transfer of an HVDC connection. Furthermore, disturbance outages are more thoroughly examined than other events.

The scope of the ENTSO-E HVDC Utilisation and Unavailability Statistics 2020 is different from the CIGRE HVDC statistics, which focuses more on outages, faults and disturbances of the HVDC links. This means that CIGRE is more detailed regarding what happens at the HVDC station, and includes transients, commutation failures, thyristor failures and so on. In general, DISTAC has the macro view and CIGRE has the micro view. But most of the data is the same for both reports.

The HVDC WG of NordAM¹ and the DISTAC group have together developed the DISTAC HVDC outage and utilization data collection so that more detailed HVDC performance data analysis will be enabled in future. Together they also updated the HVDC performance data collection guidelines according to the new features.

2.1 Contact persons

Each country is represented by at least one contact person, responsible for the statistical information of the corresponding country. The contact person can provide additional information concerning the HVDC availability and utilisation statistics. The relevant contact information is given in Appendix C.

¹The five Nordic Transmission System Operators (TSOs) founded a Nordic Asset Management Forum (NordAM) in 2009 with the main goal to increase cooperation, jointly influence, build up knowledge, create networks as well as carry out agreed surveys and development tasks within the field of Asset Management. The HVDC working group was established after a very successful task force work done in 2017.

3 Methods, definitions and calculations

To compare the utilisation and availability between HVDC links, different ways of using them must be discerned and understood. This chapter explains the availability and utilisation categories used to differentiate between means of utilising HVDC links. The hierarchy of the categories is illustrated in Figure 3.1.

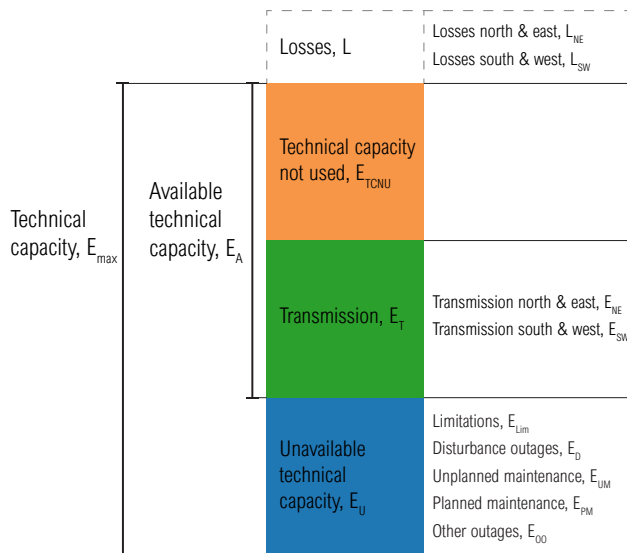

Figure 3.1: The hierarchy of the availability and utilisation categories used in the HVDC statistics.

The *technical capacity* (E_{max}) of an HVDC link is the maximum energy that can be physically received through the HVDC link to the converter station, excluding all HVDC link losses, during a year. The technical capacity is divided into two categories: *available technical capacity* (E_A) and *unavailable technical capacity* (E_U).

The *available technical capacity* (E_A) is divided into technical capacity that has been *transmitted* (E_T) and into technical capacity that could have been transmitted/utilised, that is, *technical capacity not used* (E_{TCNU}).

Transmitted energy (E_T) is the sum of transmitted energy in both directions of the HVDC link. Energy transferred to the north or east side of the HVDC link is called *transmission north and east* (E_{NE}) (previously export), and energy transferred to the south or west side of the HVDC link is called *transmission south and west* (E_{SW}) (previously import). It does not include *losses* (L), that is, the energy losses in any of the HVDC link components during transmission. It should be noted that these values are measurements and therefore considered factual.

Technical capacity not used (E_{TCNU}) is the amount of energy that has not been transmitted or been unavailable due to limitations or outages.

The *unavailable technical capacity* (E_U) is the part of the *technical capacity* (E_{max}) that could not be utilised. It has five sub-categories: *limitations* (E_{Lim}), *disturbance outages* (E_D), *unplanned maintenance* (E_{UM}), *planned maintenance* (E_{PM}) and *other outages* (E_{OO}). An outage occurs when the HVDC link is fully disconnected from the system and the transfer capacity is reduced to zero. A limitation occurs when the capacity of the link has been reduced by between 0–100 %. Limitations and the outages are described in more detail below:

- A *limitation* (E_{Lim}) is a condition when the transmission capacity of an HVDC link is limited, that is, the power transmission capacity of the link is less than the rated power. The limitation is always motivated from a technical perspective, but not always concerning the link itself. The most common causes of limitations are:
 - faults on any HVDC link component that do not cause a total outage;
 - faults, congestions or outages in the AC grid causing a limitation in the transmission capacity of the link;
 - seasonal variations on the transmission capacity of the HVDC link.
- *Disturbance outages* (E_D) are total outages due to a fault on the HVDC link or in the AC-grid causing a total outage of the link. A disturbance outage occurs when the protection trips the link or, in rare cases, disconnected manually. Manual disconnection is usually categorised as unplanned maintenance.
- *Unplanned maintenance outages* (E_{UM}) occurs when the link is manually disconnected for emergency or urgent repair. In general, unplanned maintenance are outages that cannot wait until the next scheduled maintenance.
- *Planned maintenance outages* (E_{PM}) are total outages due to all technically motivated actions on the HVDC link or in the AC grid intended to retain an entity in, or restore it to, a state where it can perform its required function.
- *Other outages* (E_{OO}) are outages due to any other reason except those mentioned above. This could be, for example, black start or other tests or when the markets do not need the transmission capacity of the link and the link is disconnected.

4 Technical details of the HVDC links

Table 4.1 presents the main properties of the HVDC links while Table 4.2 presents the technical properties of the HVDC lines.

Schematic presentations of the HVDC links and their converter stations, both for line-commutated converters (LCC) and voltage-source converters (VSC) are presented in Appendix A.

Table 4.1: Main properties of the HVDC links.

Link	Commissioning year	Market connection	HVDC converter type	Rated power, monopolar (MW)	Parallel monopolar capacity (MW)	Bipolar capacity
Baltic Cable	1994	Yes	LCC	600		
COBRACable	2019	Yes	VSC	700		
EstLink 1	2006	Yes	VSC	350	1000	
EstLink 2	2014	Yes	LCC	650		
Fenno-Skan 1	1989	Yes	LCC	400	1200	1200
Fenno-Skan 2	2011	Yes	LCC	800		
Kontek	1995	Yes	LCC	600		
Konti-Skan 1 ¹	2008	Yes	LCC	357.5		715
Konti-Skan 2 ¹	1988	Yes	LCC	357.5		
LitPol Link	2015	Yes	LCC	500		
NordBalt	2016	Yes	VSC	700		
NorNed	2008	Yes	LCC	700		
Skagerrak 1	1977	Yes	LCC	236	1000	1000
Skagerrak 2	1977	Yes	LCC	236		
Skagerrak 3	1993	Yes	LCC	478		
Skagerrak 4	2014	Yes	VSC	682		
Storebaelt	2010	Yes	LCC	600		
SwePol	2000	Yes	LCC	600		
Vyborg Link ²	1981, 1982, 1984, 2000	Partly	LCC	1400		
Total				10972	3940	2200

¹ The rated capacity of Konti-Skan 1 and 2 was updated to 715 MW in both directions on 1 February 2020 (357.5 MW per link). The rated capacity was previously asymmetric depending on the flow direction: 740 MW towards east (370+370) and 680 MW towards west (340+340). The reason of the asymmetric rated capacity was due to historical limitations and reserve requirements, along with transmission measurements only being done in DK1.

² Each commissioning increased capacity by 350 MW. However, the total commercial capacity of Vyborg Link is 1300 MW. Fingrid Oyj, the Finnish transmission system operator, allocates 100 MW for reserves.

Table 4.2: Technical details of the HVDC links

Link	Physical length (km)	Length of mass cable (km)	Length of PEX cable (km)	Length of DC overhead line (km)	Length of DC back-to-back connection (km)
Baltic Cable	262	250		12	
COBRACable	325	325	650 (2×325)	0	
EstLink 1	105		210 (2×105)		
EstLink 2	171	157		14	
Fenno-Skan 1	233	200		33	
Fenno-Skan 2	299	196		103	
Kontek	160		160		
Konti-Skan 1	150	89		61	
Konti-Skan 2	150	89		61	
LitPol Link	< 1				< 1
NordBalt	450		2×450		
NorNed	580	580			
Skagerrak 1	212.5	133.6		78.5	
Skagerrak 2	211.4	132.9		78.5	
Skagerrak 3	212.9	134.4		78.5	
Skagerrak 4	226	226			
Storebaelt	57	57			
SwePol	254	254			
Vyborg Link	< 1				< 1

5 Results

This chapter presents the utilisation and unavailability of all the HVDC links as well as individual presentations of each HVDC link connected to the Nordic and Baltic power system.

Section 5.1 provides an overview of the HVDC links for the year 2020 and Section 5.2 provides an overview of the years 2012–2020. Section 5.3 presents the availability and utilisation of each HVDC link for the year 2020 as well as an annual overview of the utilisation and a trend of the utilisation and the number of outages for the years 2012–2020.

5.1 Overview of 2020

In 2020, 58.8 TWh of electric energy was transmitted through the Nordic and Baltic HVDC links. The total number of disturbance outages registered was 51, preventing 4.1 TWh of potential energy transmission, or 4.3 % of the total technical capacity (E_{\max}).

Maintenance outages amounted to 4.8 TWh, or 5.0 % of the total technical capacity (E_{\max}), and limitations reduced the transmission capacity by 4.0 TWh (4.2 % of the total technical HVDC transmission capacity).

Figure 5.1 presents the overview of the availability and utilisation of HVDC statistics at an aggregated level, thus allowing to compare links with each other. It should be noted that the usages of the links show big variations. Most links are market dependent, some are mostly used only in one direction, and some are used for technical reasons to control power flow for system stability according to agreements. Appendix D shows the overviews of the HVDC links using the same values as Figure 5.1 but ranked according to the highest unavailable technical capacity, according to the highest transmission, and according to the highest technical capacity not used.

Figure 5.2 compares the availability and utilisation of the HVDC links between bidding zones. That is, it measures the utilisation of the energy transfer capacity between the bidding zones ignoring the performance of individual links. However, the number of HVDC links connecting different bidding zones varies. A map portraying the bidding zones and each HVDC link is presented in Figure 5.10.

Figure 5.3 presents the percentage unavailable technical capacity (E_U) of the annual technical capacity (E_{\max}) due to the disturbance outages. Figure 5.4 presents the number of all disturbance, maintenance and other outages. The explanations for the most notable unavailability in 2020 are listed below. Further details are presented in Section 5.3.

Review of notable unavailable technical capacity 2020

- Baltic Cable had 4 disturbance outages of which one had more severe impact. The severe disturbance outage was caused by a fault on the DC submarine cable, probably cut by an anchor of a boat, and lasted 29 days. The limitations on Baltic Cable were mainly due to maintenance in the AC grid.
- COBRACable had no maintenance outages but two disturbance outages in 2020. The first was a minor outage due to a glycol pump trip in August. The second disturbance outage was due to a submarine cable fault in September and lasted until 8 January 2021.
- The annual maintenance of Kontek lasted 18 days starting from 31 August. Unfortunately, a fault on the land cable on the German side resulted in 94 days of further unplanned maintenance shortly after the planned maintenance.
- Konti-Skan 1 and 2 limitations were mainly due to maintenances on the AC-grid on both the Danish and Swedish side. Additionally, Konti-Skan 2 had a 20-day disturbance outage due to a fault in the smoothing reactor.
- LitPol planned maintenance was annual maintenance that lasted 23 days starting from late September.
- NorNed limitations were due to AC filter problems in Holland.
- Skagerrak 1 had 1 major disturbance outage in 2020, which was caused by a cable fault due to a ship and lasted 88 days.
- Skagerrak 2 had 1 major disturbance outage in 2020, which was caused by a cable fault due to a ship and lasted 123 days.
- Skagerrak 4 had an additional planned maintenance outage from May to July to cut cable samples for tests and investigations.
- Skagerrak 1, 2, 3 and 4 have been limited due to “careful operation” since the Skagerrak 4 cable faults in December 2019. In 2020, the north direction (DK1→NO2) was prioritised until March, after which the south direction (NO2→DK1) was prioritised.
- SwePol had 1 more severe disturbance outage in 2020, which was caused by a fire in the AC-filter on the Polish side in January. It took 19 days to bring the HVDC link back online after it.
- Vyborg Link planned maintenances were mainly annual maintenances, which lasted 31 days in July and 44 days during August–September.

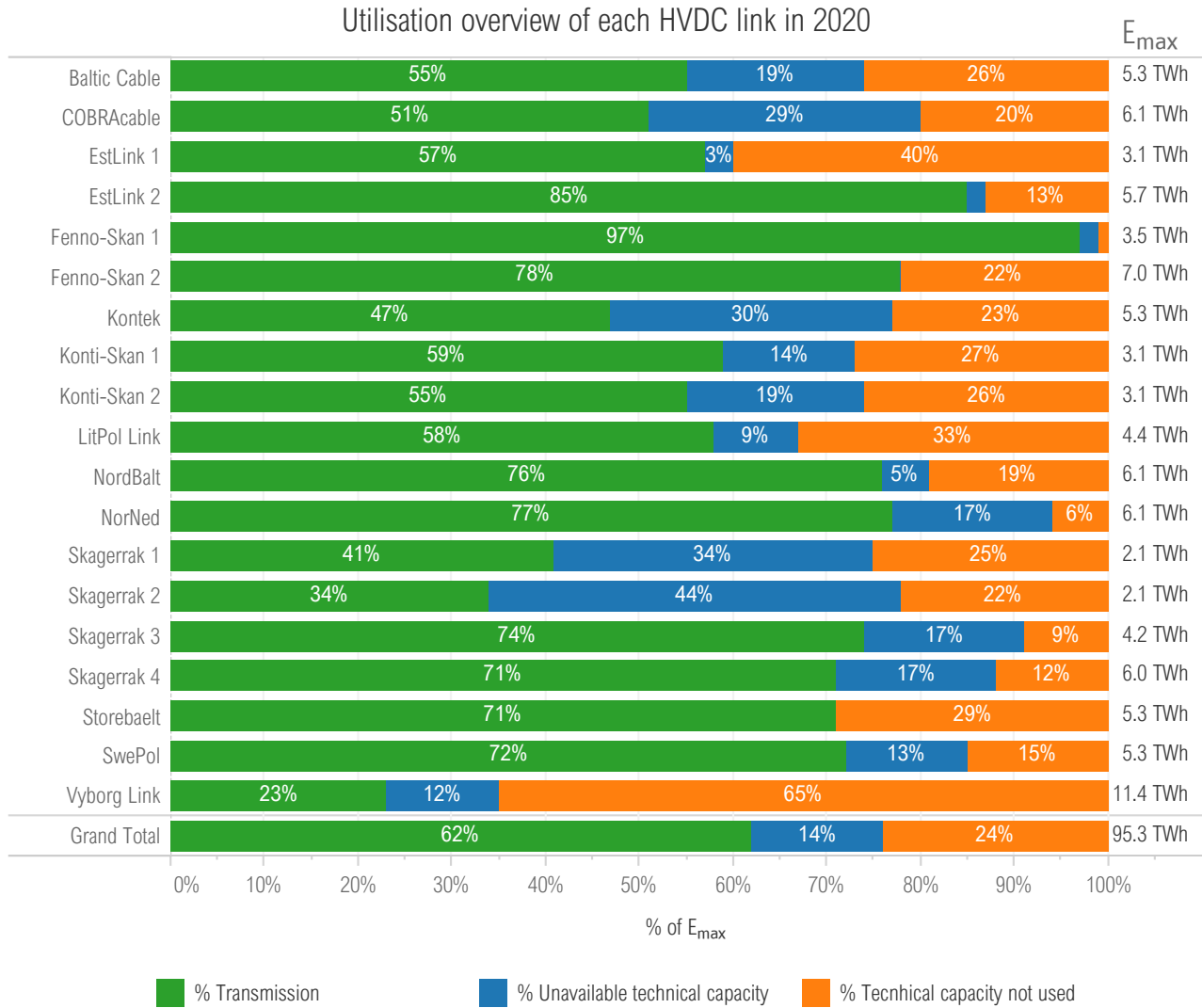

Figure 5.1: Overview of the availability and utilisation of each HVDC link in 2020. The unavailable technical capacity (E_U) is the amount of technical capacity (E_{max}) not available due to limitations or outages. Transmission (E_T) is the amount of technical capacity (E_{max}) transmitted through the HVDC link. Technical capacity not used (E_{TCNU}) is the amount of energy that has not been transmitted or been unavailable due to limitations or outages. More detailed explanations can be read in Chapter 3. Appendix D shows the overviews of the HVDC links using the same values as Figure 5.1 but ranked according to the highest unavailable technical capacity, according to the highest transmission, and according to the highest technical capacity not used.

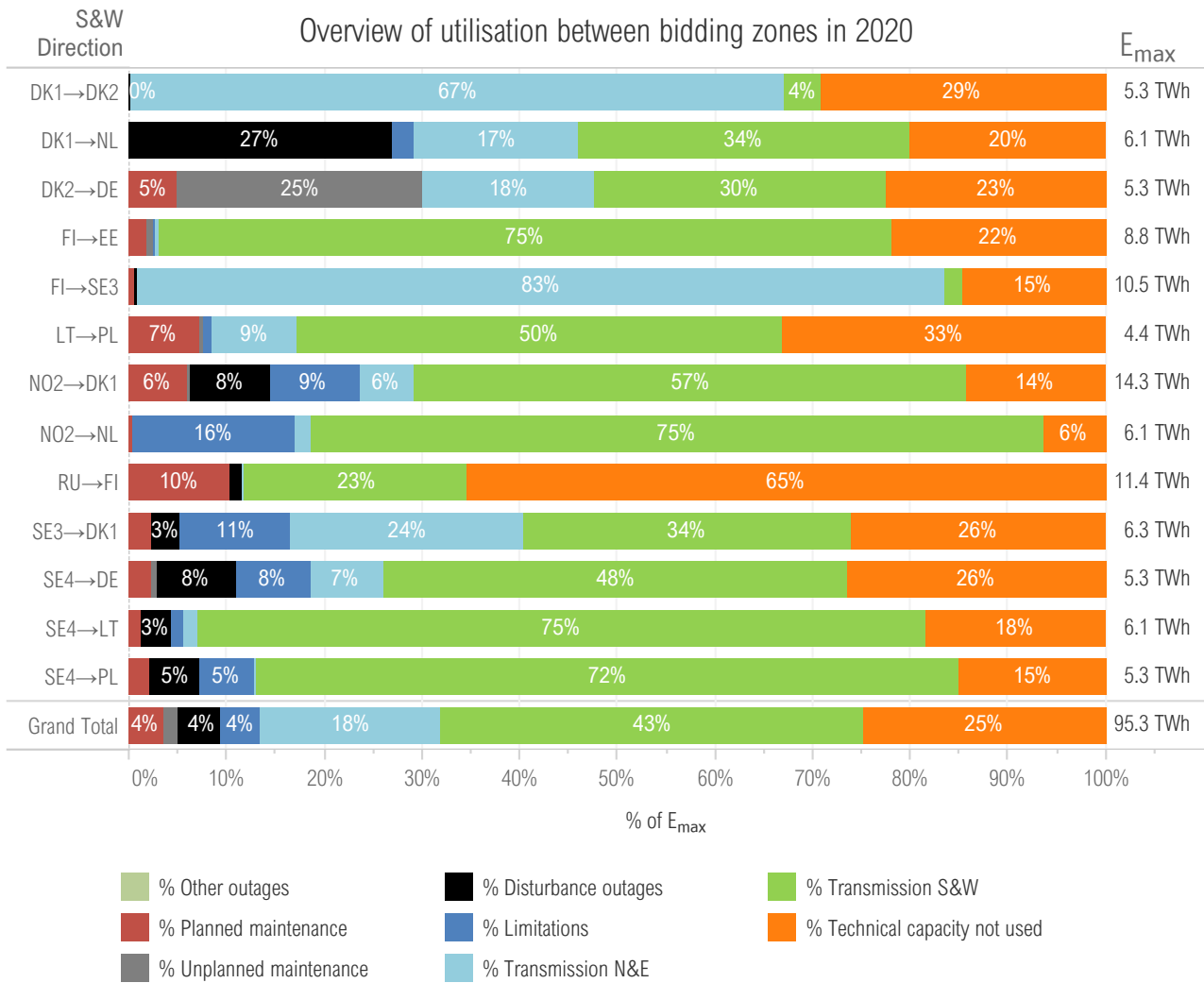

Figure 5.2: Availability and utilisation overview per bidding zone in 2020. The categories are explained in Chapter 3.

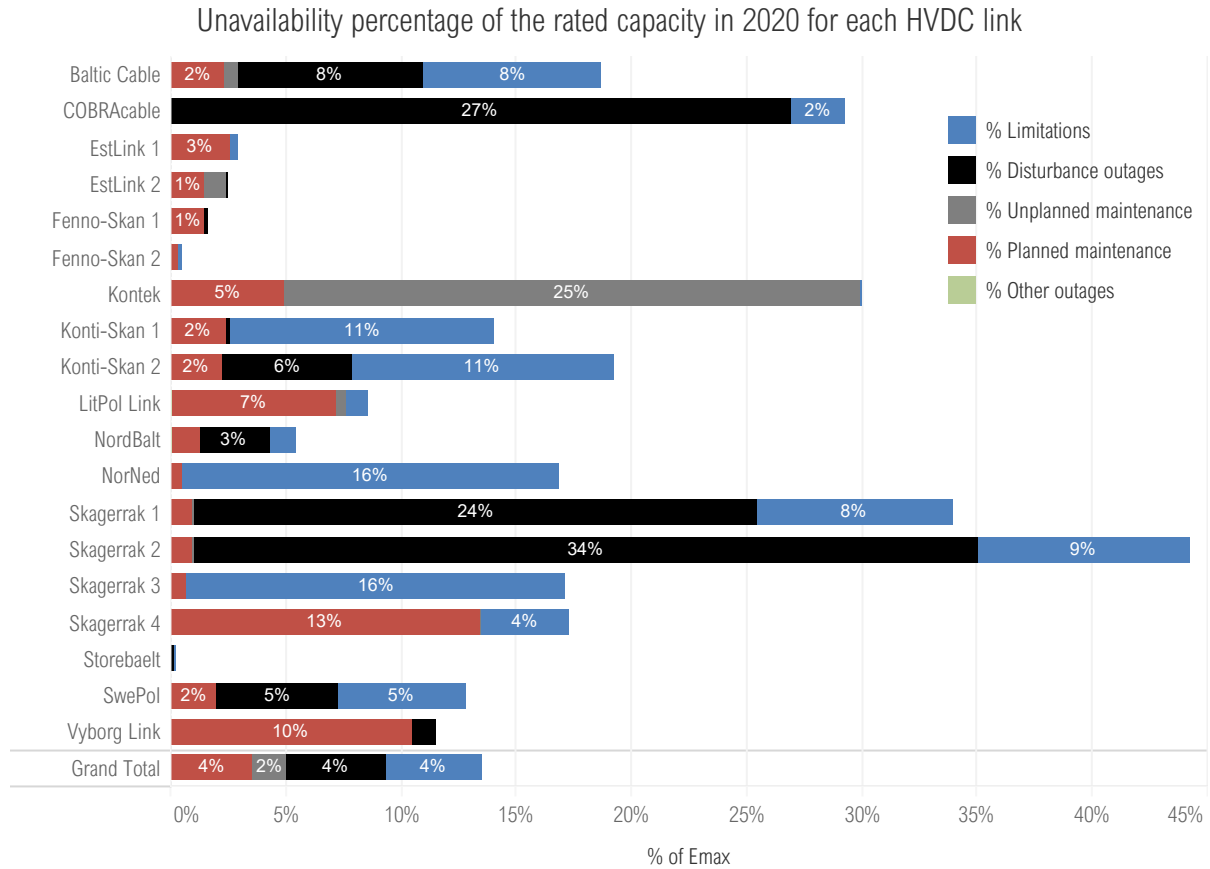

Figure 5.3: Percentage distribution of unavailable technical capacity (E_U) due to limitations, disturbance outages, unplanned and planned maintenance and other outages for each link in 2020.

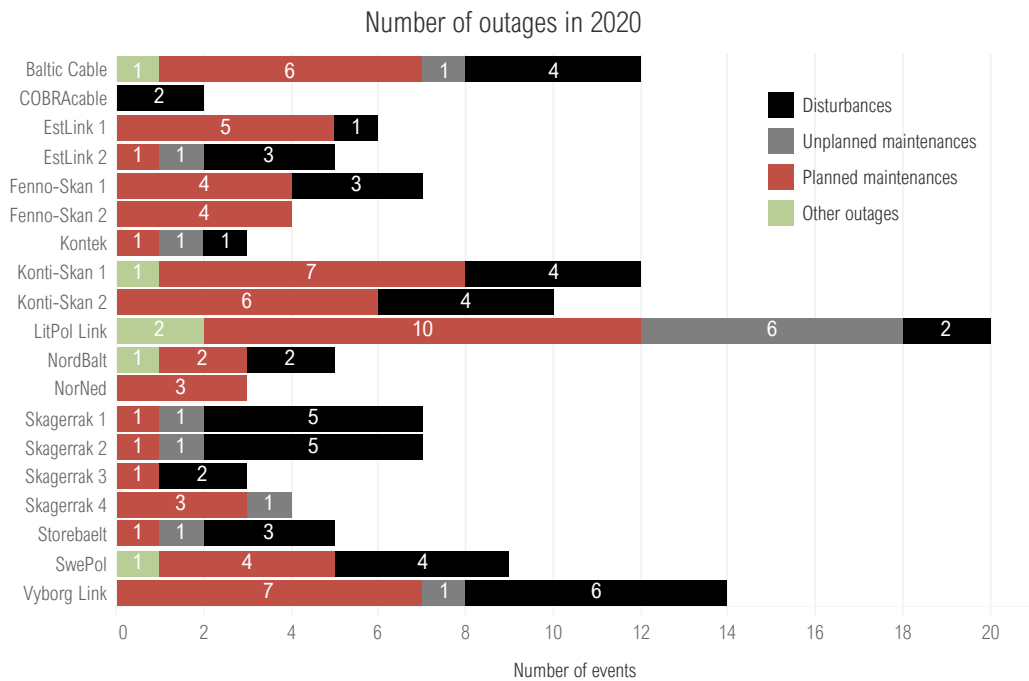

Figure 5.4: The number of disturbance outages, unplanned maintenance and planned maintenance outages and other outages for each link in 2020.

5.2 Overview of years 2012–2020

Because the HVDC links are an important component in the Nordic and Baltic power systems, it is also very interesting to see how the links have been utilised during the past years. Figure 5.5 presents the annual utilisation (%) of all HVDC links and Figure 5.6 presents the annual utilisation with all utilisation categories.

As can be seen, the percentage distribution of transmission (E_T) and unavailable technical capacity (E_U) is showing a slight increasing trend after a significant drop in 2012 and 2013. However, the total technical capacity (E_{max}) of all HVDC links has increased, as can be seen in Figure 5.6.

Figure 5.7 presents the combined annual hourly utilisation rate for all HVDC links. Figure 5.8 presents the annual distri-

bution of unavailable technical capacity (E_U) in percentages of the maximum technical capacity (E_{max}) for each unavailability category. Figure 5.9 presents the percentage of hours a link has been affected by either a limitation, unplanned or planned maintenance or disturbance or other outages. A higher value in the percentage of hours may indicate that the corresponding type of event has not fully disconnected the affected HVDC link from the system, thereby reducing the transmission capacity to zero. A lower value may, instead, indicate that the corresponding event type has affected an HVDC link with a high rated capacity.

Annual utilisation (E_T), unavailability (E_U) and technical capacity not used (E_{TCNU}) percentages are presented in Table 5.1, Table 5.2 and Table 5.3, respectively.

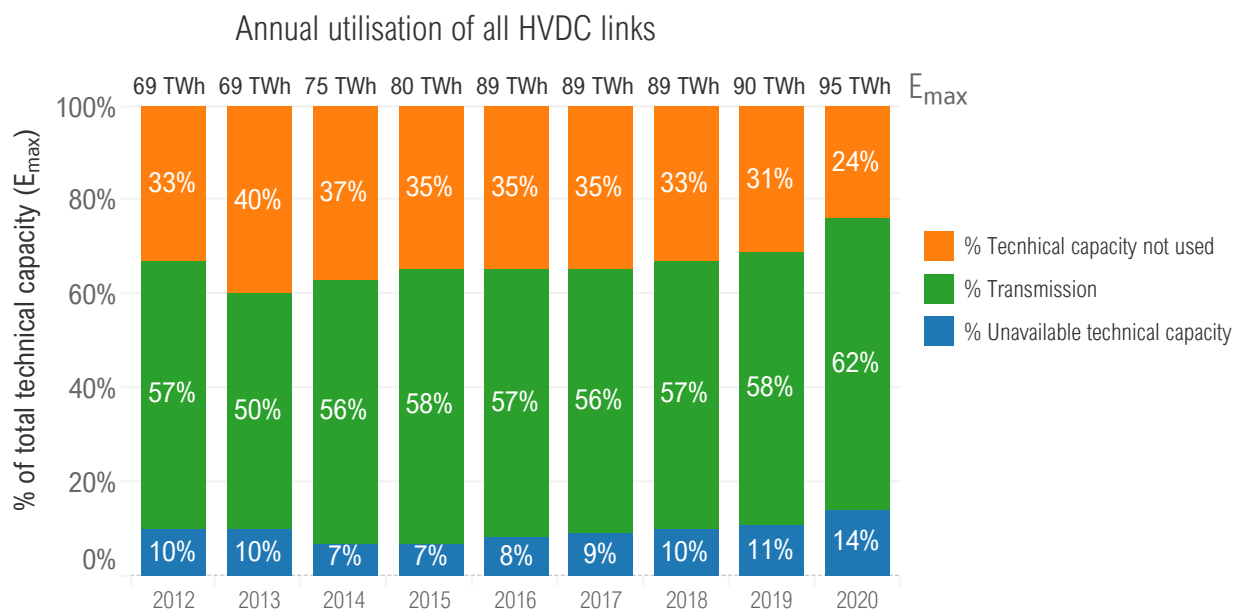

Figure 5.5: The annual utilisation percentage of all HVDC links since 2012. The unavailable technical capacity (E_U) is the amount of technical capacity (E_{max}) not available due to limitations or outages. Transmission (E_T) is the amount of technical capacity (E_{max}) transmitted through the HVDC links. Technical capacity not used (E_{TCNU}) is the residual energy that has neither been transmitted nor been unavailable due to limitations or outages. More detailed explanations can be read in Chapter 3.

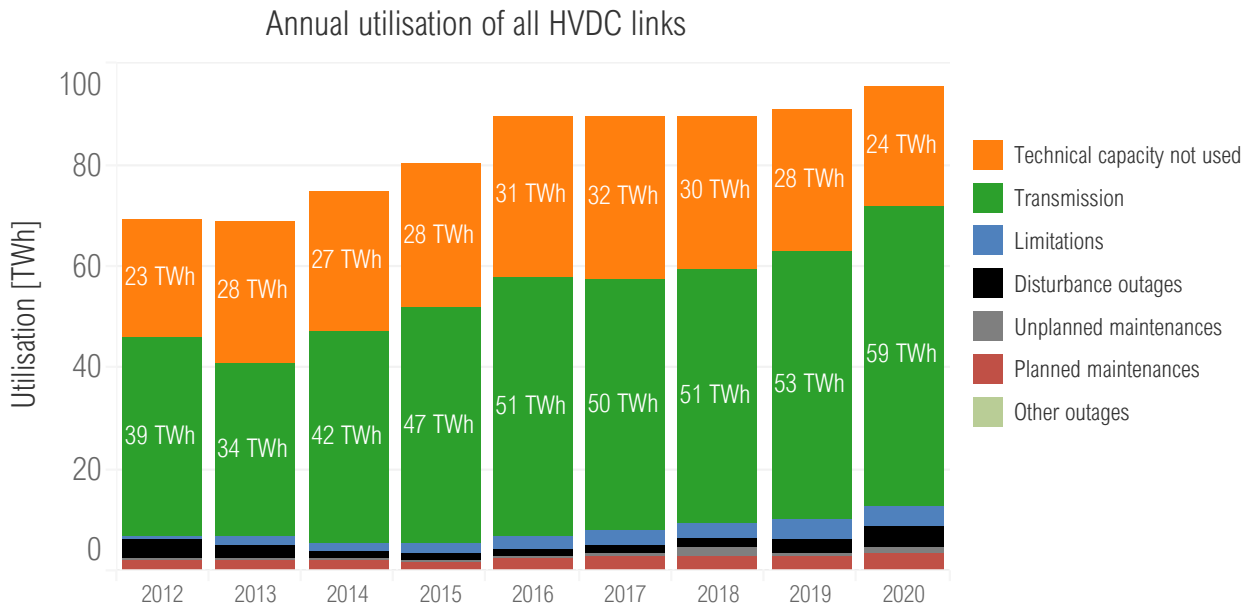

Figure 5.6: Annual utilisation of all HVDC links presented in terawatt hours (MWh). Transmission (E_T) is the amount of technical capacity (E_{max}) transmitted through the HVDC links. Limitations, disturbance outages, unplanned and planned maintenance outages and other outages form together the unavailable technical capacity (E_U). Technical capacity not used (E_{TCNU}) is the residual energy that has neither been transmitted nor been unavailable due to limitations or outages. The categories are explained in more detail in Chapter 3. From 2012, there are 14 HVDC links included. As of 2014, EstLink 2 and Skagerrak 4 were added. In 2016, LitPol Link and NordBalt were added. In late 2019, COBRACable was added. The maximum technical capacity (E_{max}) is marginally on leap years due to one extra day of operation.

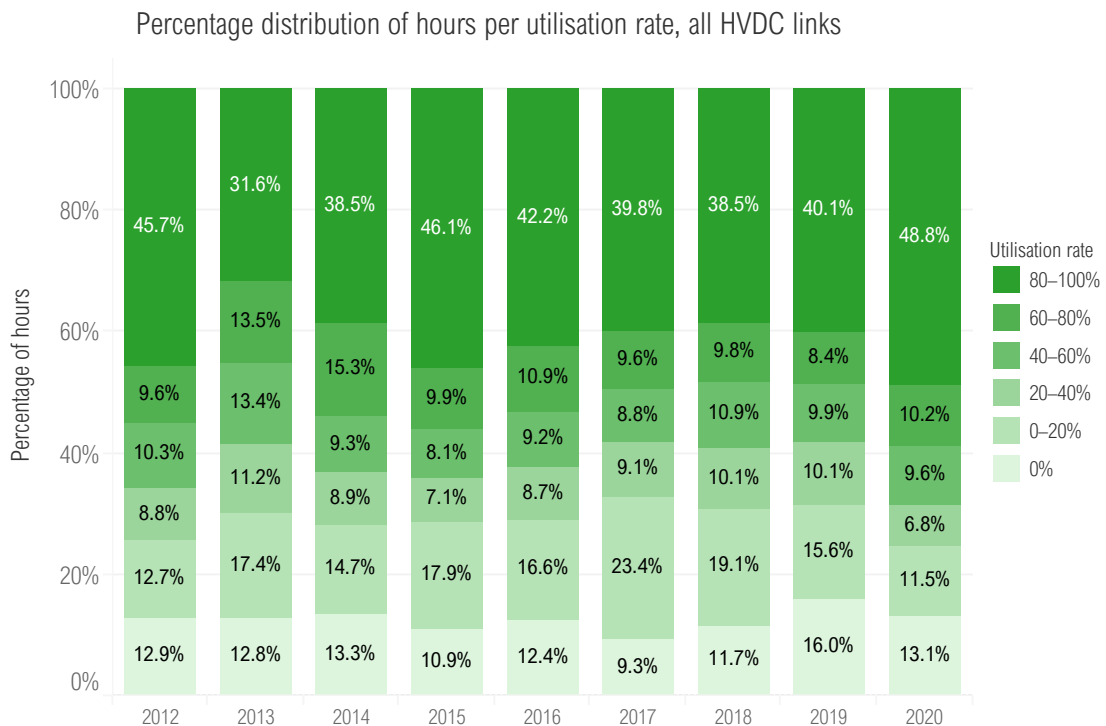

Figure 5.7: Percentage distribution of hours per utilisation rate for all HVDC links. The HVDC links were utilised by more than 80 % of their respective maximum technical capacity 48.8 % of the time during 2020.

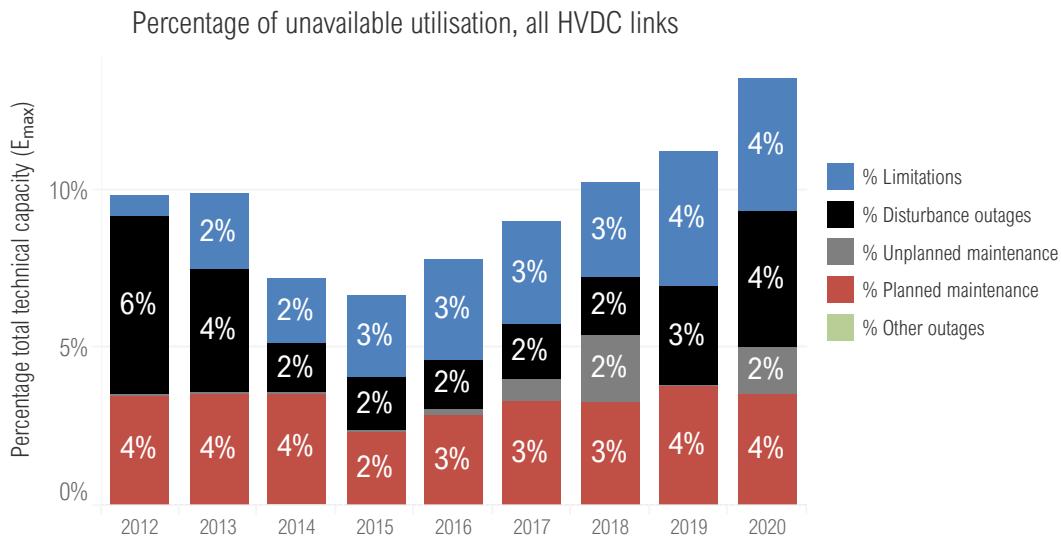

Figure 5.8: Annual distribution of unavailable technical capacity (E_U) in percentages of the maximum technical capacity (E_{max}) for each unavailability category. The unavailability categories are limitations, disturbance outages, unplanned and planned maintenance and other outages.

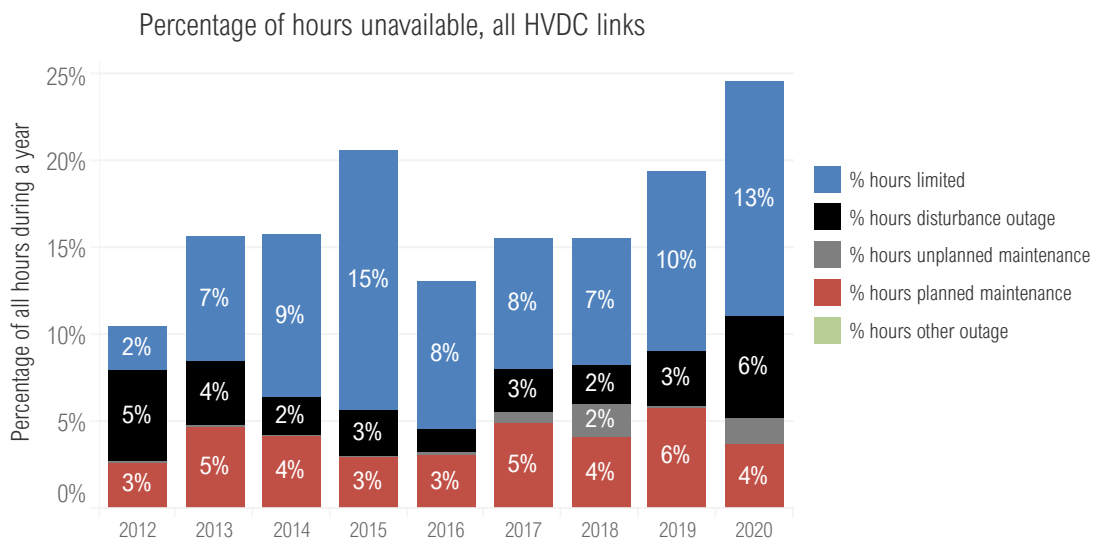

Figure 5.9: The percentage of hours all HVDC links have been affected by either a limitation, unplanned or planned maintenance or a disturbance or other outage. The percentage is calculated by counting the number of hours with a limitation or outage and dividing it by the total number of hours in a year. It should be noted that any single hour can be affected by both an outage and a limitation. A higher value in the percentage of hours may indicate that the corresponding type of event has not fully disconnected the affected HVDC link from the system, thereby reducing the transmission capacity to zero. A lower value may, instead, indicate that the corresponding event type has affected an HVDC link with a high rated capacity.

Table 5.1: Annual utilisation percentage of HVDC links per bidding zone.

	2012	2013	2014	2015	2016	2017	2018	2019	2020
DK1-DK2	44.9%	54.4%	58.3%	70.1%	78.0%	63.7%	63.4%	58.3%	70.7%
DK1-NL								79.7%	50.6%
DK2-DE	70.0%	70.1%	73.2%	74.8%	66.8%	66.3%	53.3%	68.6%	47.4%
FI-EE	58.6%	54.9%	40.7%	56.8%	42.3%	29.2%	37.0%	46.6%	75.3%
FI-SE3	53.8%	52.5%	76.2%	75.8%	77.7%	70.2%	71.8%	81.2%	84.6%
LT-PL					33.5%	46.7%	53.5%	61.5%	58.4%
NO2-DK1	67.5%	60.7%	54.5%	54.0%	60.6%	54.1%	52.7%	46.2%	62.3%
NO2-NL	89.4%	71.6%	90.5%	93.9%	72.5%	82.8%	68.3%	61.3%	76.7%
RU-FI	33.8%	35.6%	25.4%	29.1%	45.8%	49.8%	66.7%	61.5%	23.1%
SE3-DK1	55.9%	40.5%	49.3%	48.7%	58.8%	51.8%	52.7%	50.1%	57.3%
SE4-DE	59.5%	32.1%	47.5%	30.5%	43.3%	45.6%	33.2%	36.0%	54.9%
SE4-LT					43.6%	51.5%	50.5%	62.9%	76.2%
SE4-PL	52.3%	33.9%	60.9%	67.2%	55.8%	62.3%	66.1%	62.1%	72.1%
Grand Total	56.8%	49.9%	56.1%	58.2%	57.2%	55.5%	56.5%	58.3%	61.6%

Table 5.2: Annual unavailability percentage of HVDC links per bidding zone.

	2012	2013	2014	2015	2016	2017	2018	2019	2020
DK1-DK2	2.9%	9.9%	4.6%	2.4%	2.8%	1.6%	2.2%	2.5%	0.3%
DK1-NL								5.1%	29.3%
DK2-DE	5.8%	3.9%	3.5%	5.2%	10.4%	14.3%	25.9%	3.8%	30.0%
FI-EE	2.6%	5.0%	14.7%	5.8%	3.6%	0.6%	3.6%	2.2%	2.7%
FI-SE3	27.3%	17.2%	5.4%	9.5%	1.5%	1.2%	1.1%	4.7%	0.9%
LT-PL					14.0%	10.1%	6.1%	3.6%	8.6%
NO2-DK1	2.4%	7.9%	10.5%	6.5%	4.8%	18.0%	12.7%	27.0%	23.6%
NO2-NL	3.4%	19.3%	4.5%	4.2%	8.1%	8.4%	13.8%	13.0%	16.9%
RU-FI	9.8%	1.3%	0.4%	0.0%	1.5%	2.3%	5.2%	5.4%	11.5%
SE3-DK1	4.7%	10.7%	16.1%	16.7%	5.5%	6.7%	4.3%	15.8%	16.6%
SE4-DE	22.1%	18.1%	6.6%	12.5%	20.4%	27.1%	35.0%	26.2%	18.7%
SE4-LT					25.7%	16.5%	22.0%	7.6%	5.5%
SE4-PL	0.2%	3.3%	7.1%	7.3%	15.3%	5.9%	4.2%	14.0%	12.8%
Grand Total	9.8%	9.9%	7.2%	6.7%	7.8%	8.9%	10.2%	11.2%	13.5%

Table 5.3: Annual technical capacity not used percentage of HVDC links per bidding zone.

	2012	2013	2014	2015	2016	2017	2018	2019	2020
DK1-DK2	52.1%	35.6%	37.1%	27.5%	19.3%	34.7%	34.5%	39.2%	29.1%
DK1-NL								15.2%	20.1%
DK2-DE	24.3%	26.1%	23.3%	20.1%	22.8%	19.4%	20.7%	27.7%	22.6%
FI-EE	38.8%	40.0%	44.7%	37.3%	54.1%	70.2%	59.3%	51.2%	22.0%
FI-SE3	18.9%	30.3%	18.4%	14.8%	20.7%	28.6%	27.1%	14.1%	14.6%
LT-PL					52.5%	43.2%	40.3%	34.9%	33.0%
NO2-DK1	30.1%	31.4%	34.9%	39.5%	34.6%	27.9%	34.6%	26.8%	14.2%
NO2-NL	7.2%	9.1%	5.0%	1.9%	19.4%	8.8%	17.9%	25.6%	6.4%
RU-FI	56.5%	63.1%	74.2%	70.9%	52.7%	47.9%	28.2%	33.1%	65.3%
SE3-DK1	39.3%	48.8%	34.6%	34.6%	35.8%	41.4%	43.0%	34.1%	26.1%
SE4-DE	18.4%	49.8%	45.9%	57.0%	36.3%	27.4%	31.8%	37.8%	26.4%
SE4-LT					30.7%	32.1%	27.6%	29.4%	18.3%
SE4-PL	47.5%	62.8%	32.0%	25.5%	28.9%	31.8%	29.7%	23.9%	15.1%
Grand Total	33.4%	40.2%	36.8%	35.1%	35.0%	35.5%	33.3%	30.5%	24.9%

5.3 Individual presentations of each HVDC link

This section presents the performance of each HVDC link. Figure 5.10 presents the geographical location of each HVDC link. The categories used in the following presentations of each separate HVDC link are presented and defined in Chapter 3.

Note that the sums in the tables for each link may show a

technical capacity E_{max} higher than the E_{max} stated in the diagram. This is due to power flows that may momentarily be higher than rated technical capacity of the links. Other times, when power flow is below the rated technical capacity (and there is no limitation reported), the difference is registered in the category “technical capacity not used”.

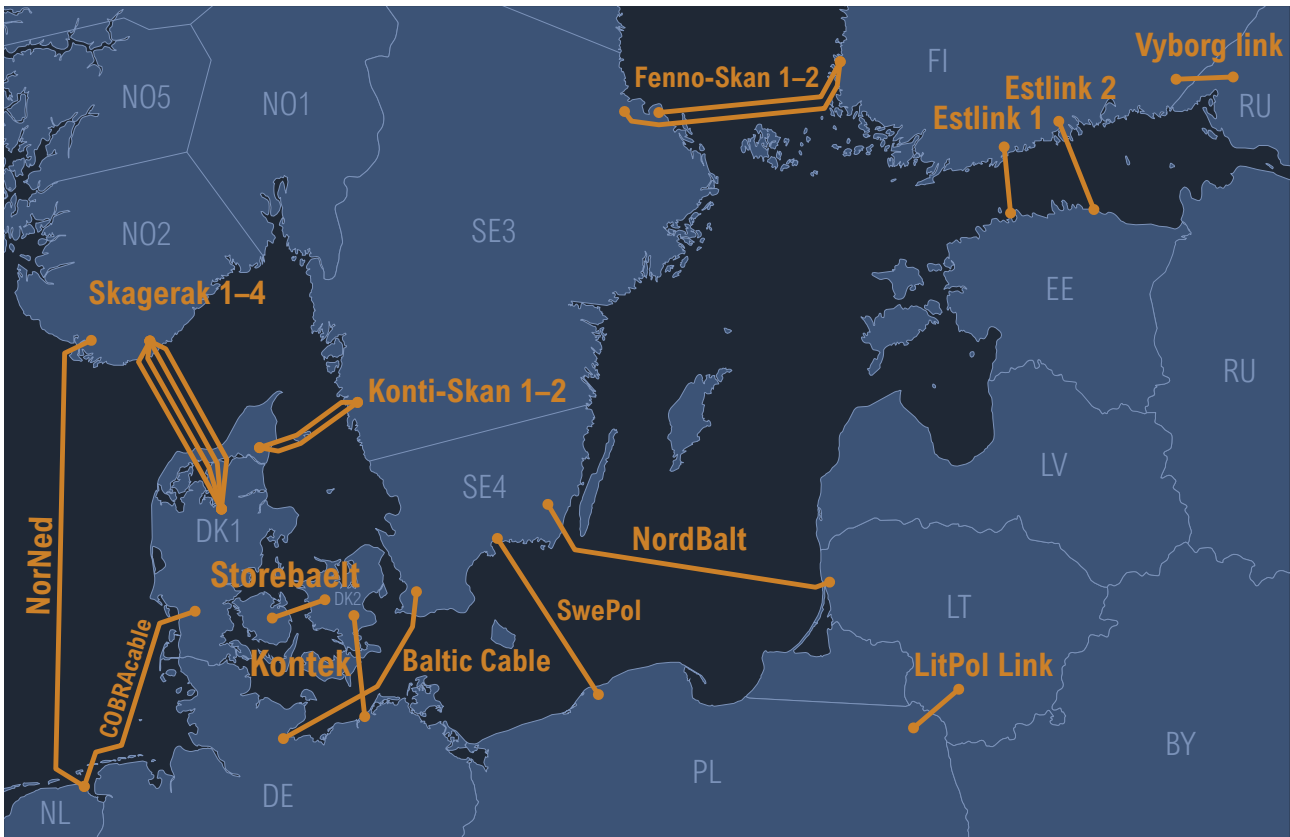

Figure 5.10: A map of the bidding zones and the 19 HVDC links included in this report.

5.3.1 Baltic Cable

Figure 5.11 presents the availability and utilisation of Baltic Cable for 2020 and Table 5.4 presents the numerical values behind it. Baltic Cable is connected between southern Sweden (bidding zone SE4) and Germany (bidding zone DE-TenneT). The operations started in 1994 and the transmission capacity is 600 MW.

In 2020, Baltic Cable had an available technical capacity of 81 %. The technical capacity not used was 19 %. Totally, 2.5 TWh (48 % of the technical capacity) was transmitted south from Sweden to Germany and 0.4 TWh (7 % of the

technical capacity) was transmitted north to Sweden.

The annual maintenance of Baltic Cable lasted 4 days in late September. Additionally, there were 4 short planned maintenance outages, 2 unplanned maintenance outages and 1 other outage during 2020. Baltic Cable had 4 disturbance outages of which one had more severe impact. The severe disturbance outage was caused by a fault on the DC submarine cable, probably cut by an anchor of a boat, and lasted 29 days.

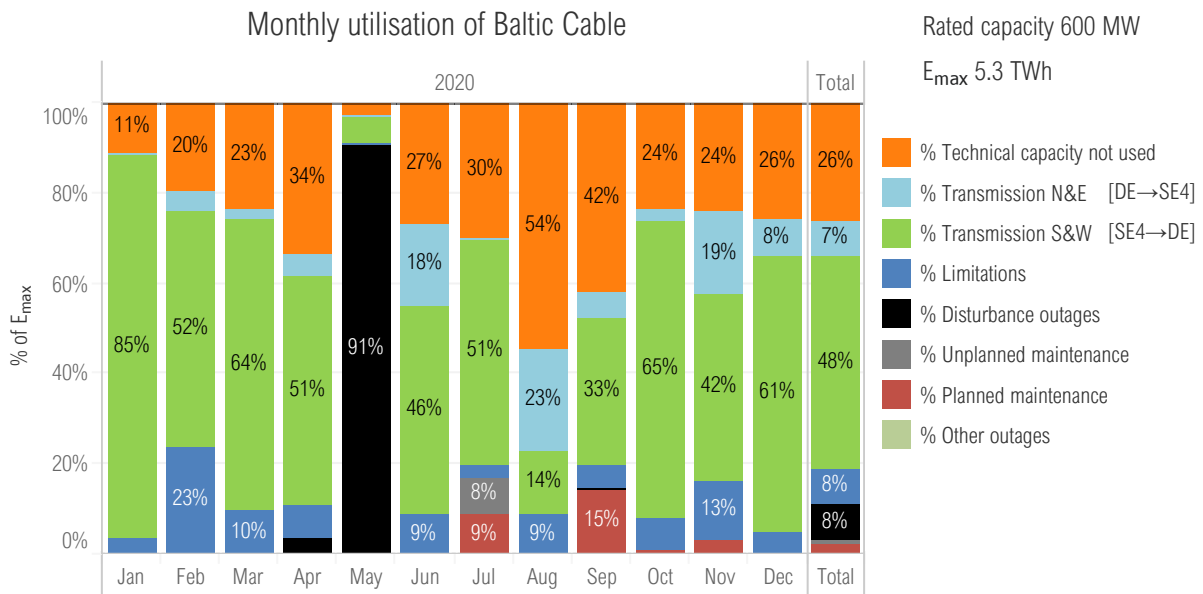

Figure 5.11: Percentage distribution of the availability and utilisation per category according to month for Baltic Cable in 2020. The availability and utilisation categories are defined in detail in Chapter 3.

Table 5.4: Monthly distribution of the technical capacity (E_{max}) for The Baltic Cable in 2020. Note that losses are not included in the technical capacity (E_{max}), as is shown in Figure 3.1.

Monthly utilisation of Baltic Cable (South & West direction SE4→DE)															
	Jan	Feb	Mar	Apr	May	Jun	Jul	Aug	Sep	Oct	Nov	Dec	Total	% total	
Technical capacity not used, GWh	50.8	82.4	105.1	145.7	11.7	116.1	133.7	242.3	181.8	105.9	103.7	114.9	1393.9	26.4%	
Transmission N&E, GWh	1.9	18.0	10.6	20.2	0.5	78.2	0.1	102.1	25.1	12.9	80.2	36.9	386.7	7.3%	
Transmission S&W, GWh	379.6	219.3	287.9	221.7	28.6	199.1	225.9	62.5	141.0	292.5	180.1	272.7	2510.8	47.5%	
Limitations, GWh	15.9	98.1	44.3	30.0	0.5	38.9	12.3	39.7	20.6	31.3	55.2	23.0	409.7	7.8%	
Disturbance outages, GWh	-	0.8	-	15.5	405.3	0.4	-	-	0.2	-	-	-	422.2	8.0%	
Unplanned maintenance, GWh	-	-	-	-	-	-	34.8	-	-	-	-	-	34.8	0.7%	
Planned maintenance, GWh	-	-	-	-	-	-	40.4	-	63.6	4.9	13.5	-	122.4	2.3%	
Other outages, GWh	-	-	-	-	-	0.2	-	-	-	-	-	-	0.2	0.0%	
Total, GWh	448.1	418.6	447.9	433.1	446.5	432.9	447.2	446.6	432.3	447.5	432.6	447.4	5280.8	100.0%	
Losses SW, GWh	9.5	5.8	7.6	6.3	0.9	5.6	7.9	3.8	4.5	7.4	4.6	7.2	71.0	1.3%	
Losses NE, GWh	-	0.4	0.2	0.4	-	1.9	-	2.3	0.6	0.2	1.7	0.8	8.7	0.2%	

Figure 5.12 presents the annual utilisation of Baltic Cable per utilisation and unavailability category for the years 2012–2020.

Figure 5.13 presents the percentage of hours of a year Baltic Cable has been affected by either a limitation, a distur-

bance outage, an unplanned or planned maintenance outage or other outage annually during the years 2012–2020. Figure 5.14 presents the annual number of disturbance outages, unplanned and planned maintenance and other outages during the years 2012–2020.

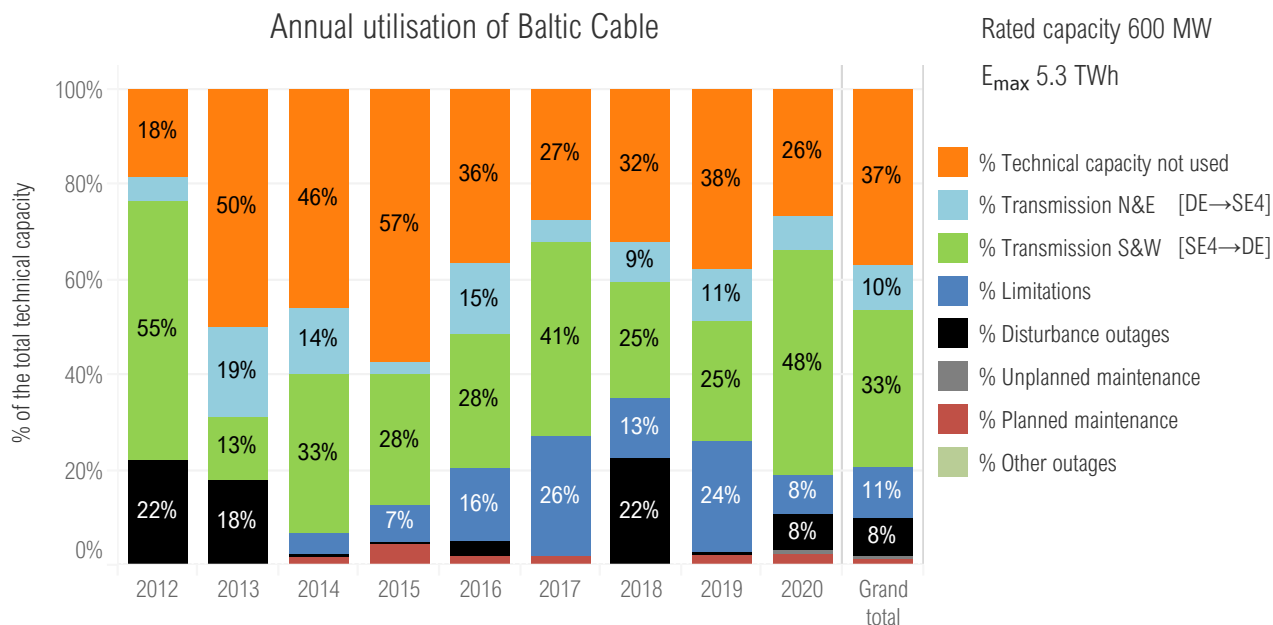

Figure 5.12: Annual utilisation of Baltic Cable according to the utilisation and unavailability categories for the years 2012–2020. The utilisation and unavailability categories are described in more detail in Chapter 3.

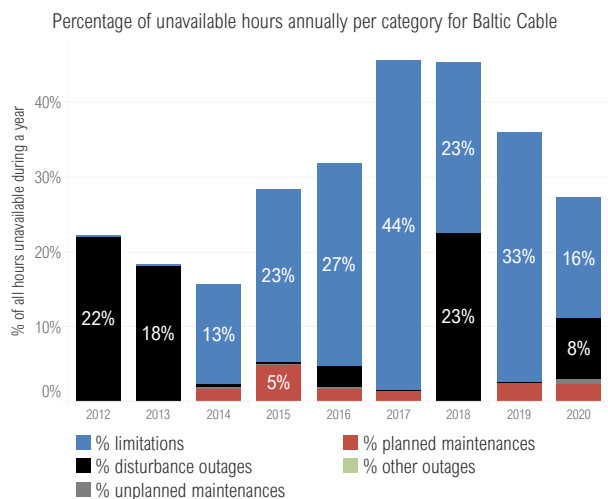

Figure 5.13: Percentage of hours Baltic Cable has been affected by either a limitation, unplanned or planned maintenance or a disturbance or other outage annually for the years 2012–2020. The percentage is calculated by counting the number of hours with a limitation or outage and dividing it by the total number of hours in a year. It should be noted, that any single hour can be affected by both an outage and a limitation.

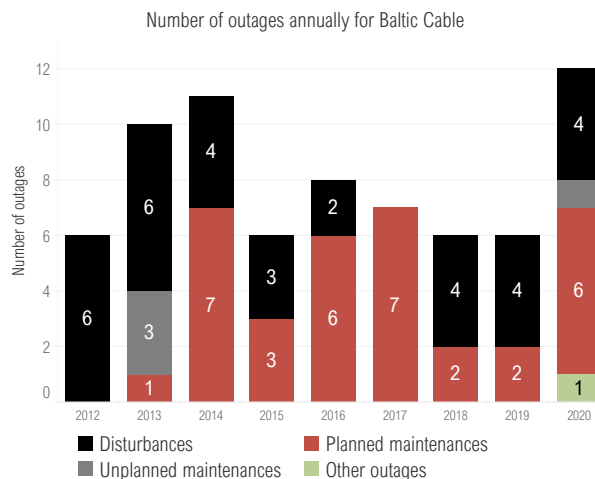

Figure 5.14: The annual number of disturbances, unplanned and planned maintenance outages and other outages for Baltic Cable for the years 2012–2020. Baltic cable has not had any other outages during the years 2012–2020.

5.3.2 COBRACable

Figure 5.15 presents the availability and utilisation of COBRACable for 2020 and Table 5.5 presents the numerical values behind it. COBRACable has been in operation since 2019. In Denmark (bidding zone DK1) it is connected to Endrup substation and in Netherlands to Eemshaven (bidding zone APX NL). COBRACable was commissioned 5 November and has a transmission capacity of 700 MW.

In 2020, COBRACable had an available technical capacity of 71 %. The technical capacity not used was 20 %. Totally,

2.1 TWh (34 % of the technical capacity) was transmitted south from Denmark to the Netherlands and 1.0 TWh (17 % of the technical capacity) was transmitted north to Denmark.

COBRACable had no maintenance outages but two disturbance outages in 2020. The first was a minor outage due to a glycol pump trip in August. The second disturbance outage was due to a submarine cable fault in September and lasted until 8 January 2021.

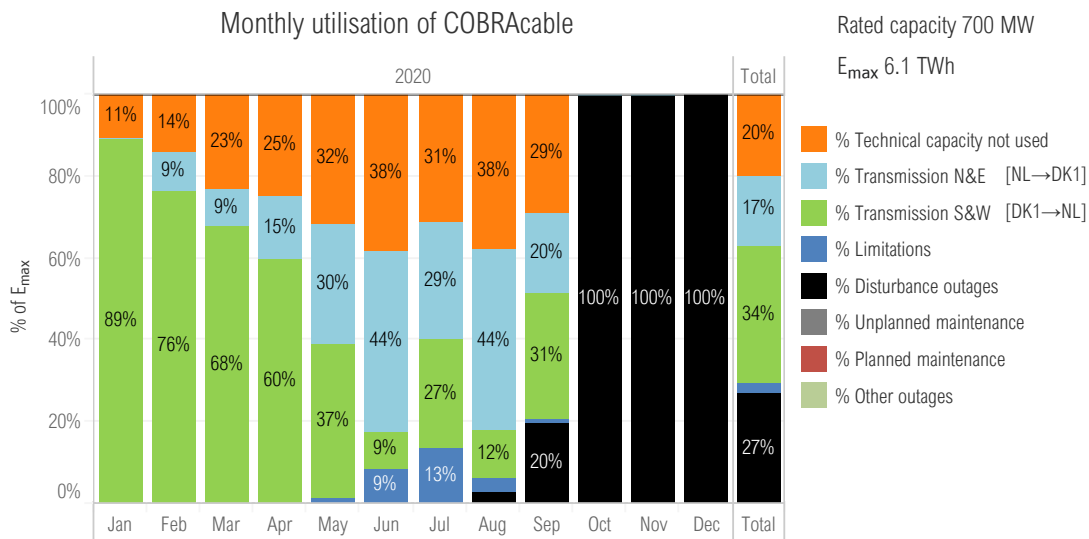

Figure 5.15: Percentage distribution of the availability and utilisation per category according to month for COBRACable in 2020. The availability and utilisation categories are defined in detail in Chapter 3.

Table 5.5: Monthly distribution of the technical capacity (E_{max}) for COBRACable in 2020. Note that losses are not included in the technical capacity (E_{max}), as is shown in Figure 3.1.

	Jan	Feb	Mar	Apr	May	Jun	Jul	Aug	Sep	Oct	Nov	Dec	Total	% total
Technical capacity not used, GWh	56.2	70.4	120.4	126.9	164.2	193.7	162.6	196.7	147.1	-	-	-	1238.1	20.1%
Transmission N&E, GWh	1.4	45.0	47.7	76.2	155.0	223.6	149.1	231.4	99.0	0.3	0.5	-	1029.3	16.7%
Transmission S&W, GWh	462.5	371.8	352.7	300.9	194.8	42.9	140.0	61.2	155.1	-	-	-	2081.9	33.9%
Limitations, GWh	0.7	-	-	-	6.8	43.8	69.2	18.0	4.0	-	-	-	142.4	2.3%
Disturbance outages, GWh	-	-	-	-	-	-	-	13.5	98.9	520.5	503.5	520.8	1657.1	27.0%
Unplanned maintenance, GWh	-	-	-	-	-	-	-	-	-	-	-	-	-	-
Planned maintenance, GWh	-	-	-	-	-	-	-	-	-	-	-	-	-	-
Other outages, GWh	-	-	-	-	-	-	-	-	-	-	-	-	-	-
Total, GWh	520.8	487.2	520.8	504.0	520.8	504.0	520.8	520.8	504.0	520.8	504.0	520.8	6148.8	100.0%
Losses SW, GWh	13.5	10.7	10.0	8.6	5.5	1.0	3.7	1.6	4.4	-	-	-	58.9	1.0%
Losses NE, GWh	0.1	1.0	1.1	1.7	3.6	5.3	3.5	5.6	2.3	-0.3	-0.1	-	23.8	0.4%

This page is intentionally left blank because COBRACable has no historical data past late 2019.

5.3.3 EstLink 1

Figure 5.16 presents the availability and utilisation of EstLink 1 for 2020 and Table 5.6 presents the numerical values behind it. EstLink 1 has been in operation since 2006 and is the first HVDC connection between Finland and Estonia. In Finland, it is connected to Espoo substation (bidding zone FI) and in Estonia, it is connected to Harku substation (bidding zone EE). The transmission capacity of EstLink 1 is 350 MW.

In 2020, EstLink 1 had an available technical capacity of 97 %. The technical capacity not used was 40 % because EstLink 2 is prioritised due to its lower transmission losses

and because EstLink 1 is often used in Automatic Frequency Control Mode. Totally, 1.7 TWh (56 % of the technical capacity) was transmitted south from Finland to Estonia and >0.1 TWh (0.4 % of the technical capacity) was transmitted north to Finland.

The annual maintenance of EstLink 1 lasted 4 days in June. Additionally, there were one 4-day planned maintenance outage to repair the roof in August and 3 other minimal ones during 2020 for minor C&P modifications and testing. Last, EstLink 1 had 1 minor disturbance outage due to a trip from an oil flow relay of the converter transformer.

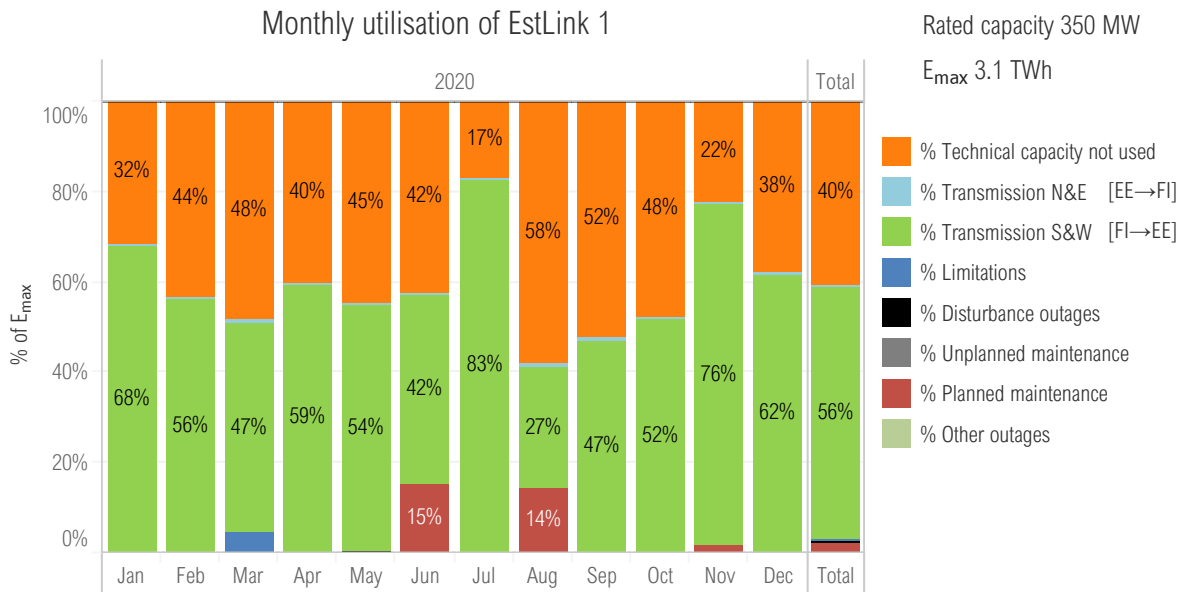

Figure 5.16: Percentage distribution of the availability and utilisation per category according to month for EstLink 1 in 2020. The availability and utilisation categories are defined in detail in Chapter 3.

Table 5.6: Monthly distribution of the technical capacity (E_{max}) for EstLink 1 in 2020. Note that losses are not included in the technical capacity (E_{max}), as is shown in Figure 3.1.

Monthly utilisation of EstLink 1 (South & West direction FI→EE)		Jan	Feb	Mar	Apr	May	Jun	Jul	Aug	Sep	Oct	Nov	Dec	Total	% total
Technical capacity not used, GWh		83.3	106.6	125.8	102.0	116.3	106.8	44.2	151.5	132.5	124.5	57.0	99.6	1250.1	40.5%
Transmission N&E, GWh		0.4	1.1	2.2	0.8	1.5	1.6	0.1	1.8	1.6	1.2	0.5	0.7	13.4	0.4%
Transmission S&W, GWh		177.9	137.3	122.4	150.3	142.2	105.5	217.5	70.4	118.6	135.5	192.7	161.9	1732.1	56.1%
Limitations, GWh		-	-	11.1	-	-	-	-	-	-	-	-	-	11.1	0.4%
Disturbance outages, GWh		-	-	-	-	1.3	-	-	-	-	-	-	-	1.3	0.0%
Unplanned maintenance., GWh		-	-	-	-	-	-	-	-	-	-	-	-	-	-
Planned maintenance, GWh		-	-	-	-	-	38.7	-	36.8	-	-	4.2	-	79.6	2.6%
Other outages, GWh		-	-	-	-	-	-	-	-	-	-	-	-	-	-
Total, GWh		261.6	244.9	261.6	253.1	261.4	252.5	261.8	260.5	252.6	261.2	254.4	262.1	3087.7	100.0%
Losses SW, GWh		-	-	-	-	-	-	-	-	-	-	-	-	-	-
Losses NE, GWh		-	-	-	-	-	-	-	-	-	-	-	-	-	-

Figure 5.17 presents the annual utilisation of EstLink 1 per utilisation and unavailability category for the years 2012–2020.

Figure 5.18 presents the percentage of hours of a year EstLink 1 has been affected by either a limitation, a distur-

bance outage, an unplanned or planned maintenance outage or other outage annually during the years 2012–2020. Figure 5.19 presents the annual number of disturbance outages, unplanned and planned maintenance and other outages during the years 2012–2020.

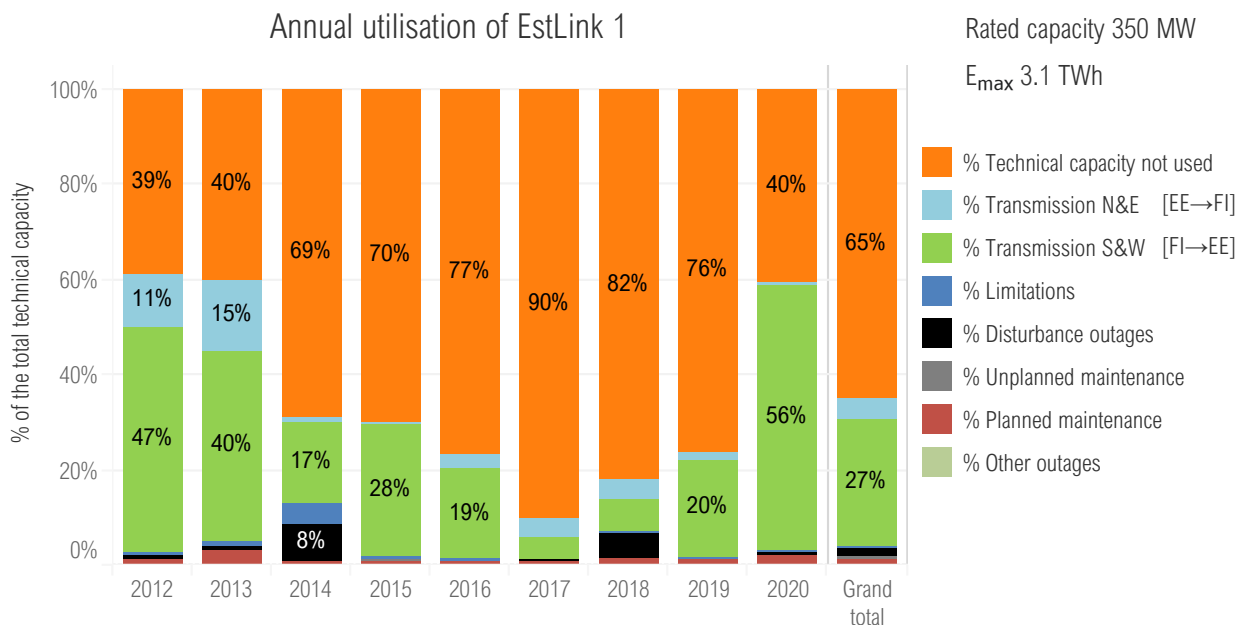

Figure 5.17: Annual utilisation of EstLink 1 according to the utilisation and unavailability categories for the years 2012–2020. The utilisation and unavailability categories are described in more detail in Chapter 3.

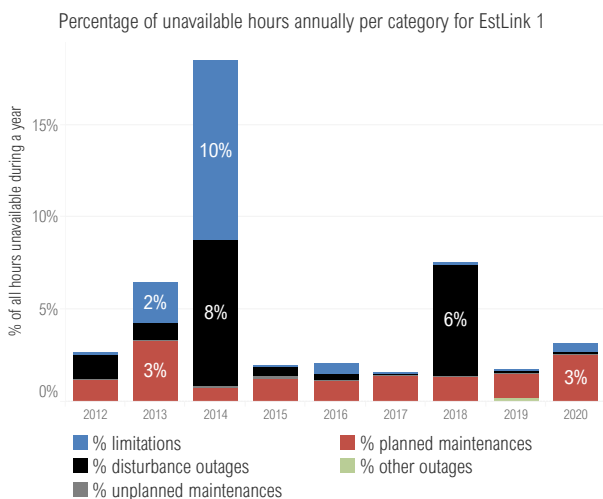

Figure 5.18: Percentage of hours EstLink 1 has been affected by either a limitation, unplanned or planned maintenance or a disturbance or other outage annually for the years 2012–2020. The percentage is calculated by counting the number of hours with a limitation or outage and dividing it by the total number of hours in a year. It should be noted, that any single hour can be affected by both an outage and a limitation.

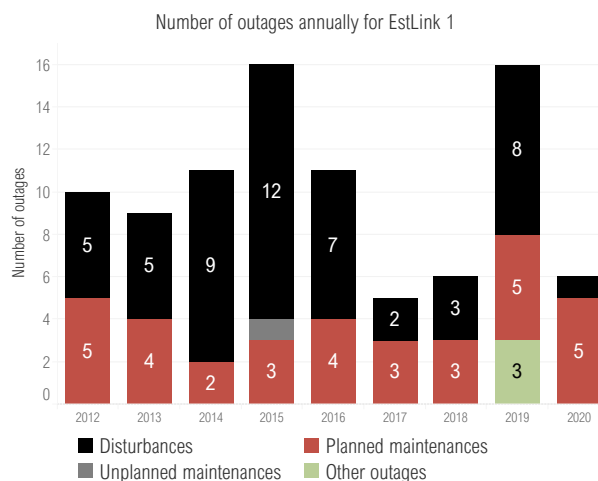

Figure 5.19: The annual number of disturbances, unplanned and planned maintenance outages and other outages for EstLink 1 for the years 2012–2020.

5.3.4 EstLink 2

Figure 5.20 presents the availability and utilisation of EstLink 2 for 2020 and Table 5.7 presents the numerical values behind it. EstLink 2 was commissioned in Feb 2014 and is the second HVDC connection between Finland and Estonia. In Finland, it is connected to Anttila substation (bidding zone FI) and in Estonia, it is connected to Püssi substation (bidding zone EE). The transmission capacity of EstLink 2 is 650 MW.

In 2020, EstLink 2 had an available technical capacity of 98 %. The technical capacity not used was 12 %. Totally, 4.9 TWh

(85 % of the technical capacity) was transmitted south from Finland to Estonia and >0.1 TWh (0.4 % of the technical capacity) was transmitted north to Finland.

The annual maintenance of EstLink 2 lasted 5 days in September–October. There were 3 very short disturbance outages in 2020 due to secondary systems. The unplanned maintenance outage in January (4 days) was continued replacement work due to a DC voltage divider equipment failure in late December 2019.

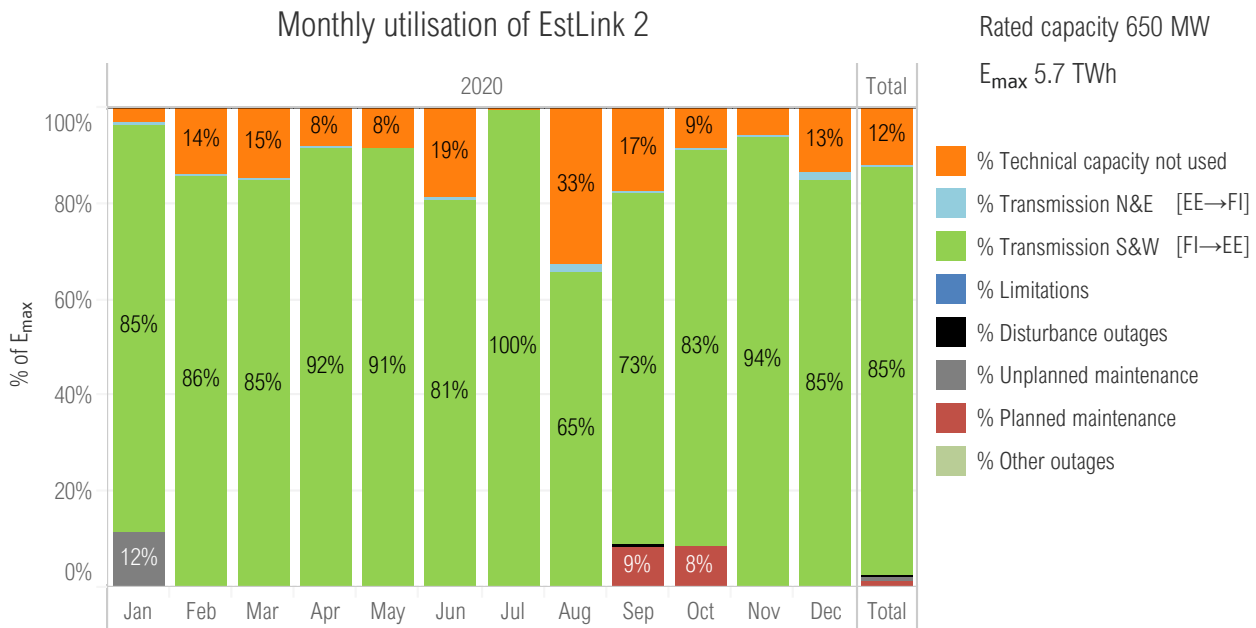

Figure 5.20: Percentage distribution of the availability and utilisation per category according to month for EstLink 2 in 2020. The availability and utilisation categories are defined in detail in Chapter 3.

Table 5.7: Monthly distribution of the technical capacity (E_{max}) for EstLink 2 in 2020. Note that losses are not included in the technical capacity (E_{max}), as is shown in Figure 3.1.

	Jan	Feb	Mar	Apr	May	Jun	Jul	Aug	Sep	Oct	Nov	Dec	Total	% total
Technical capacity not used, GWh	15.2	62.4	72.2	38.3	41.0	88.9	1.5	158.4	81.3	41.8	27.6	65.8	694.3	12.1%
Transmission N&E, GWh	-	1.4	0.6	-	-	1.1	-	9.5	1.4	0.2	-	7.6	21.8	0.4%
Transmission S&W, GWh	414.8	391.9	413.7	433.6	445.3	379.6	487.5	317.8	345.1	404.1	444.6	414.0	4892.1	85.1%
Limitations, GWh	-	-	-	-	-	-	-	-	-	-	-	-	-	-
Disturbance outages, GWh	-	-	-	-	0.9	-	-	0.2	0.4	-	-	-	1.6	0.0%
Unplanned maintenance, GWh	57.3	-	-	-	-	-	-	-	-	-	-	-	57.3	1.0%
Planned maintenance, GWh	-	-	-	-	-	-	-	-	42.6	40.7	-	-	83.3	1.4%
Other outages, GWh	-	-	-	-	-	-	-	-	-	-	-	-	-	-
Total, GWh	487.4	455.7	486.6	471.9	487.3	469.6	489.0	485.9	470.8	486.8	472.2	487.3	5750.5	100.0%
Losses SW, GWh	-	-	-	-	-	-	-	-	-	-	-	-	-	-
Losses NE, GWh	-	-	-	-	-	-	-	-	-	-	-	-	-	-

Figure 5.21 presents the annual utilisation of EstLink 2 per utilisation and unavailability category for the years 2014–2020.

Figure 5.22 presents the percentage of hours of a year EstLink 2 has been affected by either a limitation, a distur-

bance outage, an unplanned or planned maintenance outage or other outage annually during the years 2014–2020. Figure 5.23 presents the annual number of disturbance outages, unplanned and planned maintenance and other outages during the years 2014–2020.

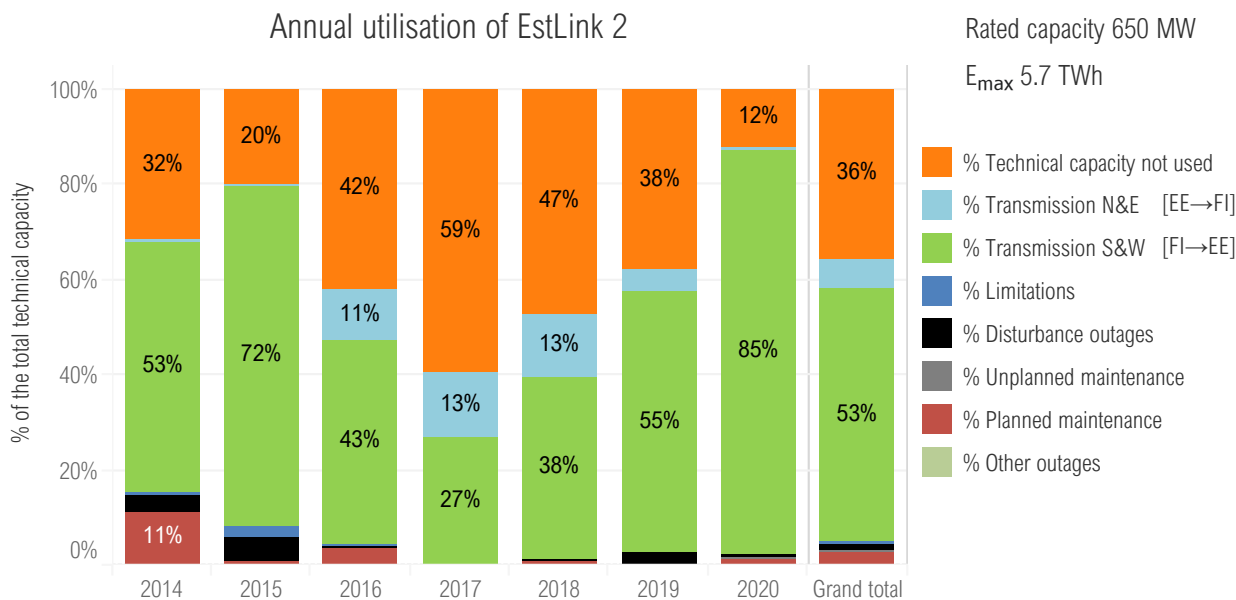

Figure 5.21: Annual utilisation of EstLink 2 according to the utilisation and unavailability categories for the years 2014–2020. The utilisation and unavailability categories are described in more detail in Chapter 3.

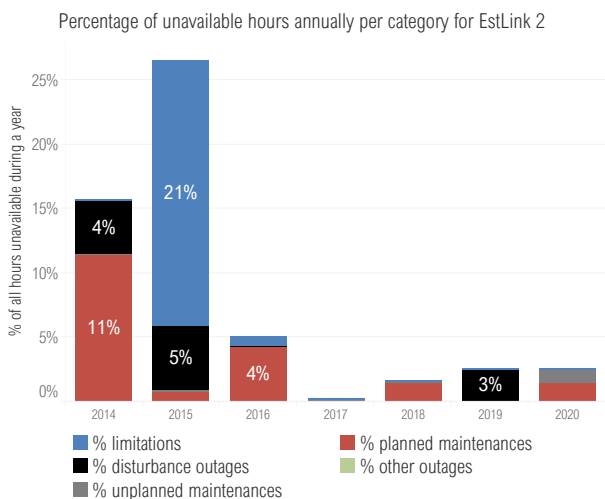

Figure 5.22: Percentage of hours EstLink 2 has been affected by either a limitation, unplanned or planned maintenance or a disturbance or other outage annually for the years 2014–2020. The percentage is calculated by counting the number of hours with a limitation or outage and dividing it by the total number of hours in a year. It should be noted, that any single hour can be affected by both an outage and a limitation.

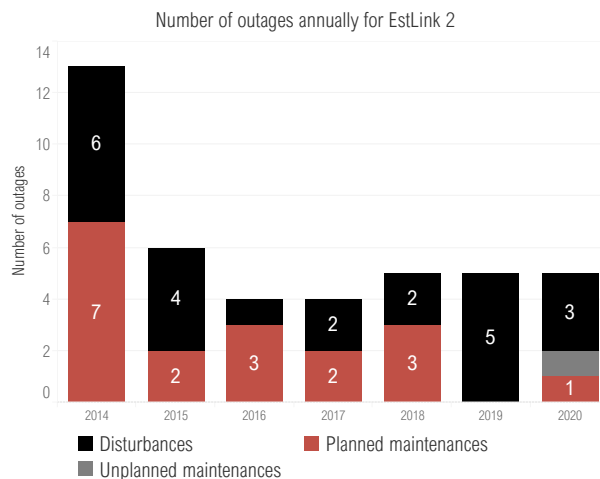

Figure 5.23: The annual number of disturbances, unplanned and planned maintenance outages and other outages for EstLink 2 for the years 2014–2020. EstLink 2 had neither unplanned maintenance nor other outages during this period.

5.3.5 Fenno-Skan 1

Figure 5.24 presents the availability and utilisation of Fenno-Skan 1 for 2020 and Table 5.8 presents the numerical values behind it. Fenno-Skan 1 has been in operation since 1989 and is the first HVDC connection between Finland and Sweden. In Finland (bidding zone FI), Fenno-Skan 1 is connected to Rauma and in Sweden to Dannebo (bidding zone SE3). The transmission capacity used to be 500 MW during summer and 550 MW during winter but was permanently decreased to 400 MW on 1 July 2014 after detailed DC-cable investigations were completed. The investigations were started after a cable fault 12 February 2013.

In 2020, Fenno-Skan 1 had an available technical capacity of 98 %. The technical capacity not used was 1 %. Totally, >0.1 TWh (0.4 % of the technical capacity) was transmitted

west from Finland to Sweden and 3.4 TWh (97 % of the technical capacity) was transmitted east to Finland.

The annual maintenance of Fenno-Skan 1 lasted 4 days in late September. Additionally, there were 3 planned maintenance outages for correcting purposes. Fenno-Skan 1 had 3 disturbance outages with minimal impact during 2020 due to faults in cooling and auxiliary systems and DC measurement.

It should be noted, that Fenno-Skan 1 and 2 is sometimes operated at equivalent transmission levels but with reversed directions to keep the temperature of Fenno-Skan 1 at adequate levels. The utilisation is still regarded as transmission even though the resulting net exchange between Finland and Sweden is zero.

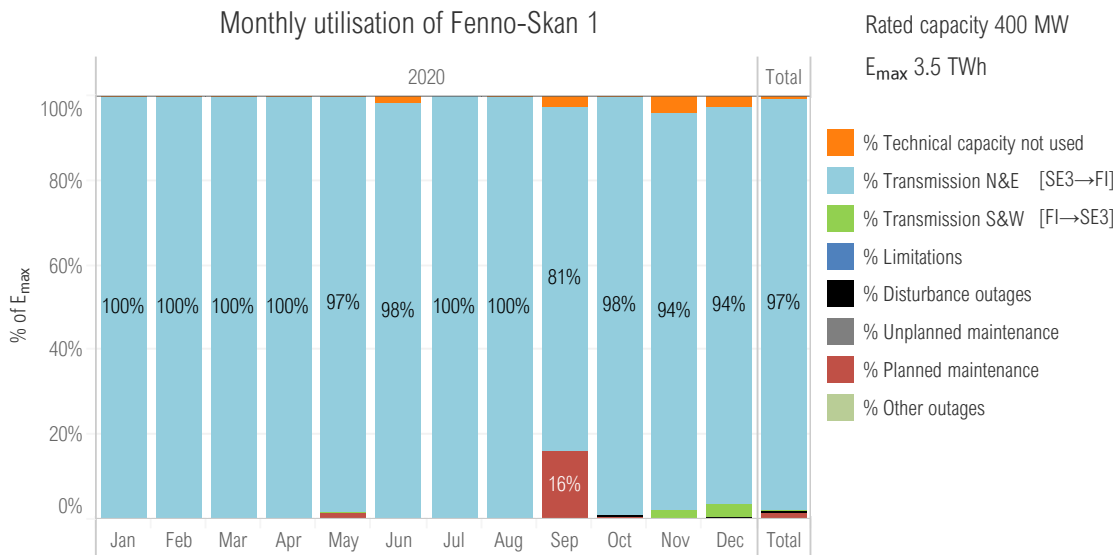

Figure 5.24: Percentage distribution of the availability and utilisation per category according to month for Fenno-Skan 1 in 2020. The availability and utilisation categories are defined in detail in Chapter 3.

Table 5.8: Monthly distribution of the technical capacity (E_{max}) for Fenno-Skan 1 in 2020. Note that losses are not included in the technical capacity (E_{max}), as is shown in Figure 3.1.

Monthly utilisation of Fenno-Skan 1 (South & West direction FI→SE3)															
	Jan	Feb	Mar	Apr	May	Jun	Jul	Aug	Sep	Oct	Nov	Dec	Total	% total	
Technical capacity not used, GWh	0.2	1.3	0.4	-	1.8	5.3	-	0.1	7.3	1.8	11.3	8.3	37.7	1.1%	
Transmission N&E, GWh	298.4	278.1	298.1	288.6	290.6	283.7	298.8	298.5	234.5	293.1	271.0	279.1	3412.6	96.9%	
Transmission S&W, GWh	-	-	-	-	-	-	-	-	-	-	6.1	9.5	15.6	0.4%	
Limitations, GWh	-	-	-	-	-	-	-	-	-	-	-	-	-	-	
Disturbance outages, GWh	-	-	-	-	2.1	-	-	-	-	0.9	-	1.3	4.3	0.1%	
Unplanned maintenance, GWh	-	-	-	-	-	-	-	-	-	-	-	-	-	-	
Planned maintenance, GWh	-	-	-	-	3.8	-	-	-	46.6	2.4	-	-	52.8	1.5%	
Other outages, GWh	-	-	-	-	-	-	-	-	-	-	-	-	-	-	
Total, GWh	298.6	279.3	298.6	288.6	298.3	289.0	298.8	298.6	288.4	298.1	288.4	298.2	3522.9	100.0%	
Losses SW, GWh	-	-	-	-	-	-	-	-	-	-	0.2	0.3	0.5	0.0%	
Losses NE, GWh	8.1	7.0	7.5	7.2	7.2	7.6	7.5	7.8	6.3	7.5	7.1	7.4	88.1	2.5%	

Figure 5.25 presents the annual utilisation of Fenno-Skan 1 per utilisation and unavailability category for the years 2012–2020.

Figure 5.26 presents the percentage of hours of a year Fenno-Skan 1 has been affected by either a limitation, a distur-

bance outage, an unplanned or planned maintenance outage or other outage annually during the years 2012–2020. Figure 5.27 presents the annual number of disturbance outages, unplanned and planned maintenance and other outages during the years 2012–2020.

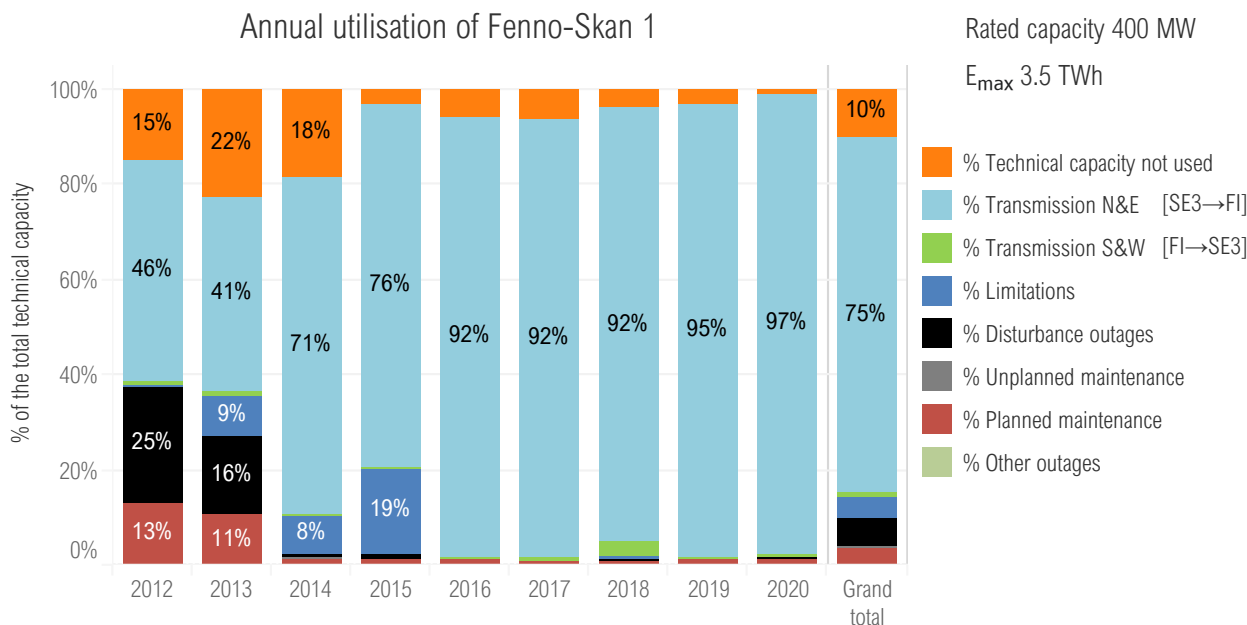

Figure 5.25: Annual utilisation of Fenno-Skan 1 according to the utilisation and unavailability categories for the years 2012–2020. The utilisation and unavailability categories are described in more detail in Chapter 3.

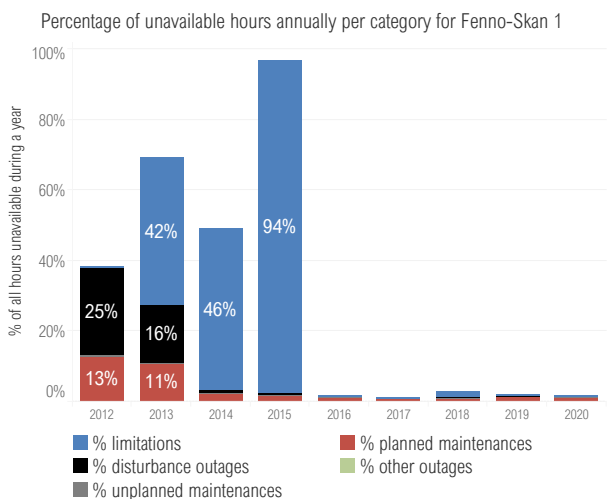

Figure 5.26: Percentage of hours Fenno-Skan 1 has been affected by either a limitation, unplanned or planned maintenance or a disturbance or other outage annually for the years 2012–2020. The percentage is calculated by counting the number of hours with a limitation or outage and dividing it by the total number of hours in a year. It should be noted, that any single hour can be affected by both an outage and a limitation.

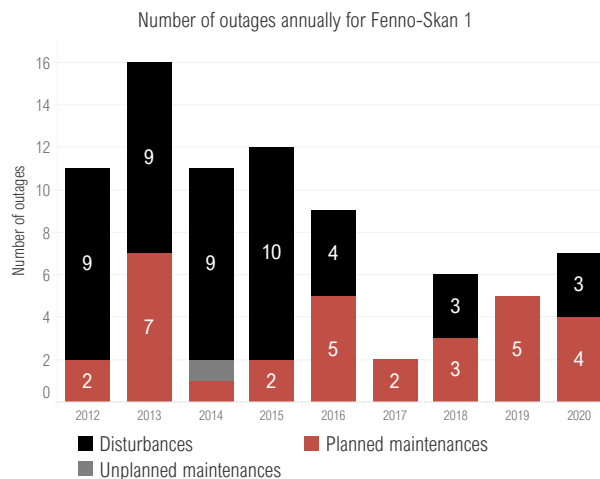

Figure 5.27: The annual number of disturbances, unplanned and planned maintenance outages and other outages for Fenno-Skan 1 during 2012–2020. Fenno-Skan 1 had no other outages during the years 2012–2020.

5.3.6 Fenno-Skan 2

Figure 5.28 presents the availability and utilisation of Fenno-Skan 2 for 2020 and Table 5.9 presents the numerical values behind it. Fenno-Skan 2 has been in operation since 2011 and is the second HVDC connection between Finland and Sweden. In Finland (bidding zone FI) Fenno-Skan 2 is connected to Rauma and in Sweden to Finnböle (bidding zone SE3). The transmission capacity of Fenno-Skan 2 is 800 MW.

In 2020, Fenno-Skan 2 had an available technical capacity of 99.5 %. The technical capacity not used was 21 %. Totally, 0.2 TWh (3 % of the technical capacity) was transmitted west from Finland to Sweden and 5.3 TWh (75 % of the technical capacity) was transmitted east to Finland.

Fenno-Skan 2 had no annual maintenance during 2020 but 4 short planned maintenance outages mainly for corrective purposes. Normally, there is annual maintenance of HVDC links but for Fenno-Skan 2 the maintenance happens every second year. Fenno-Skan 2 had no disturbance outages during 2020 – only a disturbance limitation due to trees falling on electrode overhead line during a storm.

It should be noted, that Fenno-Skan 1 and 2 is sometimes operated at equivalent transmission levels but with reversed directions to keep the temperature of Fenno-Skan 1 at adequate levels. The utilisation is still regarded as transmission even though the resulting net exchange between Finland and Sweden is zero.

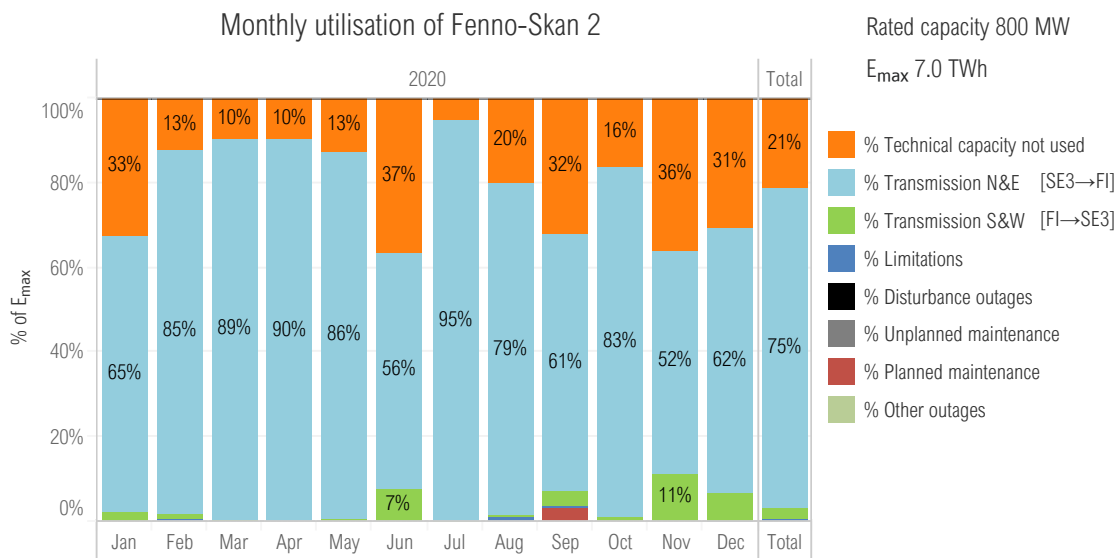

Figure 5.28: Percentage distribution of the availability and utilisation per category according to month for Fenno-Skan 2 in 2020. The availability and utilisation categories are defined in detail in Chapter 3.

Table 5.9: Monthly distribution of the technical capacity (E_{max}) for Fenno-Skan 2 in 2020. Note that losses are not included in the technical capacity (E_{max}), as is shown in Figure 3.1.

	Jan	Feb	Mar	Apr	May	Jun	Jul	Aug	Sep	Oct	Nov	Dec	Total	% total
Technical capacity not used, GWh	194.9	70.1	59.1	56.2	77.6	211.9	31.9	121.0	185.0	98.1	208.4	184.5	1498.6	21.3%
Transmission N&E, GWh	388.4	475.9	532.6	520.3	514.2	321.2	563.6	467.7	350.7	491.2	302.2	371.6	5299.6	75.4%
Transmission S&W, GWh	12.1	7.7	0.4	-	3.7	43.1	0.1	2.7	18.7	6.0	65.5	38.4	198.5	2.8%
Limitations, GWh	-	3.4	-	-	-	-	0.1	4.2	2.9	-	-	0.8	11.3	0.2%
Disturbance outages, GWh	-	-	-	-	-	-	-	-	-	-	-	-	-	-
Unplanned maintenance., GWh	-	-	-	-	-	-	-	-	-	-	-	-	-	-
Planned maintenance, GWh	-	-	3.5	-	-	-	-	-	18.9	-	-	-	22.4	0.3%
Other outages, GWh	-	-	-	-	-	-	-	-	-	-	-	-	-	-
Total, GWh	595.4	557.1	595.6	576.4	595.6	576.2	595.7	595.5	576.2	595.4	576.1	595.3	7030.4	100.0%
Losses SW, GWh	0.2	0.1	-	-	0.1	0.9	-	0.1	0.3	0.1	1.3	0.7	3.7	0.1%
Losses NE, GWh	7.9	10.4	11.7	11.4	11.3	6.5	13.0	10.0	7.5	10.8	6.2	7.8	114.5	1.6%

Figure 5.29 presents the annual utilisation of Fenno-Skan 2 per utilisation and unavailability category for the years 2012–2020.

Figure 5.30 presents the percentage of hours of a year Fenno-Skan 2 has been affected by either a limitation, a distur-

bance outage, an unplanned or planned maintenance outage or other outage annually during the years 2012–2020. Figure 5.31 presents the annual number of disturbance outages, unplanned and planned maintenance and other outages during the years 2012–2020.

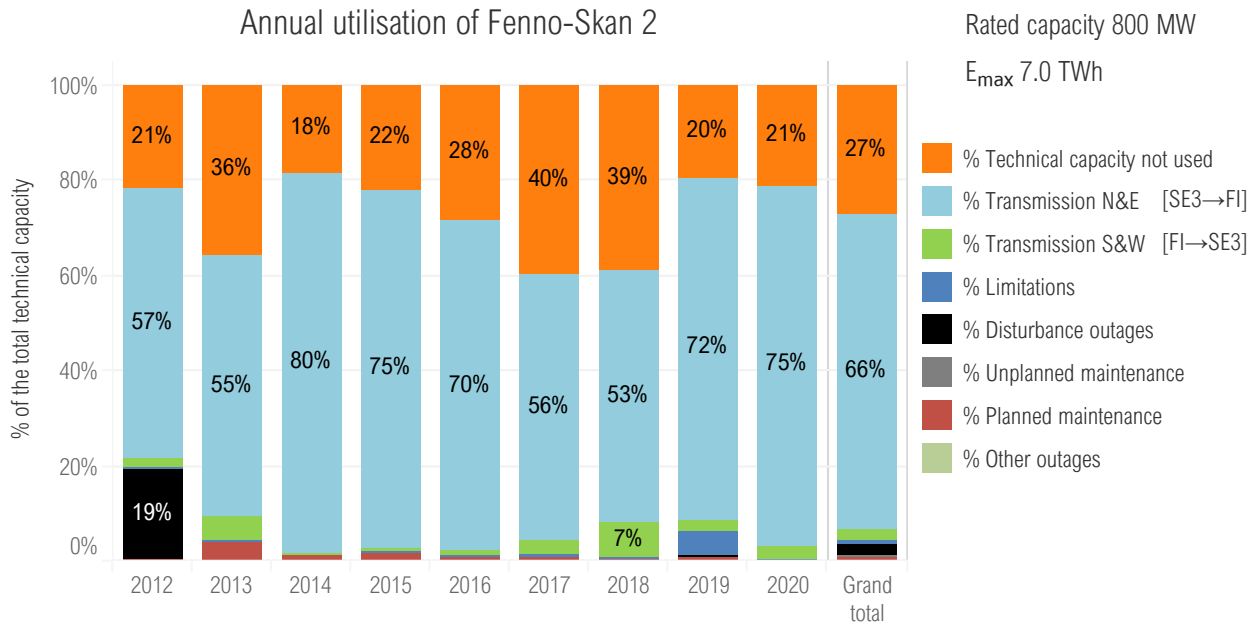

Figure 5.29: Annual utilisation of Fenno-Skan 2 according to the utilisation and unavailability categories for the years 2012–2020. The utilisation and unavailability categories are described in more detail in Chapter 3.

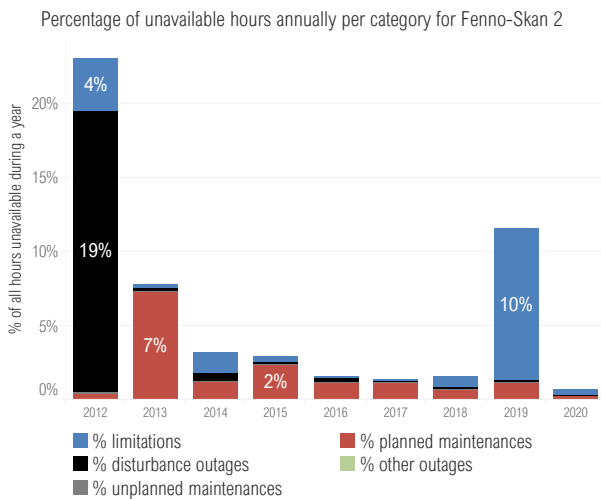

Figure 5.30: Percentage of hours Fenno-Skan 2 has been affected by either a limitation, unplanned or planned maintenance or a disturbance or other outage annually for the years 2012–2020. The percentage is calculated by counting the number of hours with a limitation or outage and dividing it by the total number of hours in a year. It should be noted, that any single hour can be affected by both an outage and a limitation.

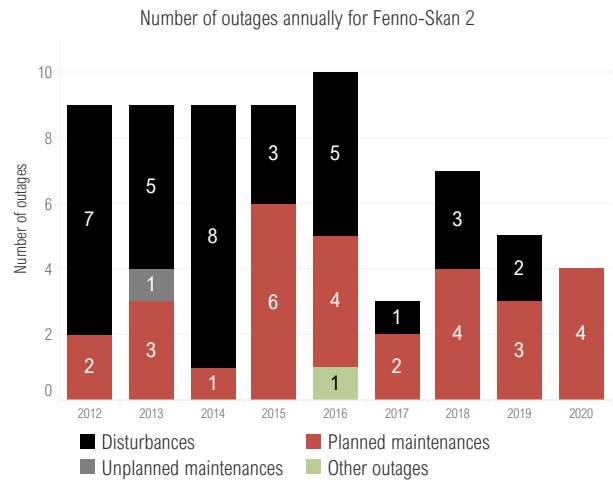

Figure 5.31: The annual number of disturbances, unplanned and planned maintenance outages and other outages for Fenno-Skan 2 for the years 2012–2020.

5.3.7 Kontek

Figure 5.32 presents the availability and utilisation of Kontek for 2020 and Table 5.10 presents the numerical values behind it. Kontek has been in operation since 1995. In Denmark it is connected to Bjaeverskov (bidding zone DK2) and in Germany to Bentwisch (bidding zone DE-50Hertz). The transmission capacity of Kontek is 600 MW.

In 2020, Kontek had an available technical capacity of 70 %. The technical capacity not used was 23 %. Totally, 1.6 TWh (30 % of the technical capacity) was transmitted south from

Denmark to Germany and 0.9 TWh (18 % of the technical capacity) was transmitted north to Denmark.

The annual maintenance of Kontek lasted 18 days starting from 31 August. Unfortunately, a fault on the land cable on the German side resulted in 94 days of further unplanned maintenance shortly after the planned maintenance. Kontek had one minor disturbance outage due to an operational error during switching of AC-filters in February.

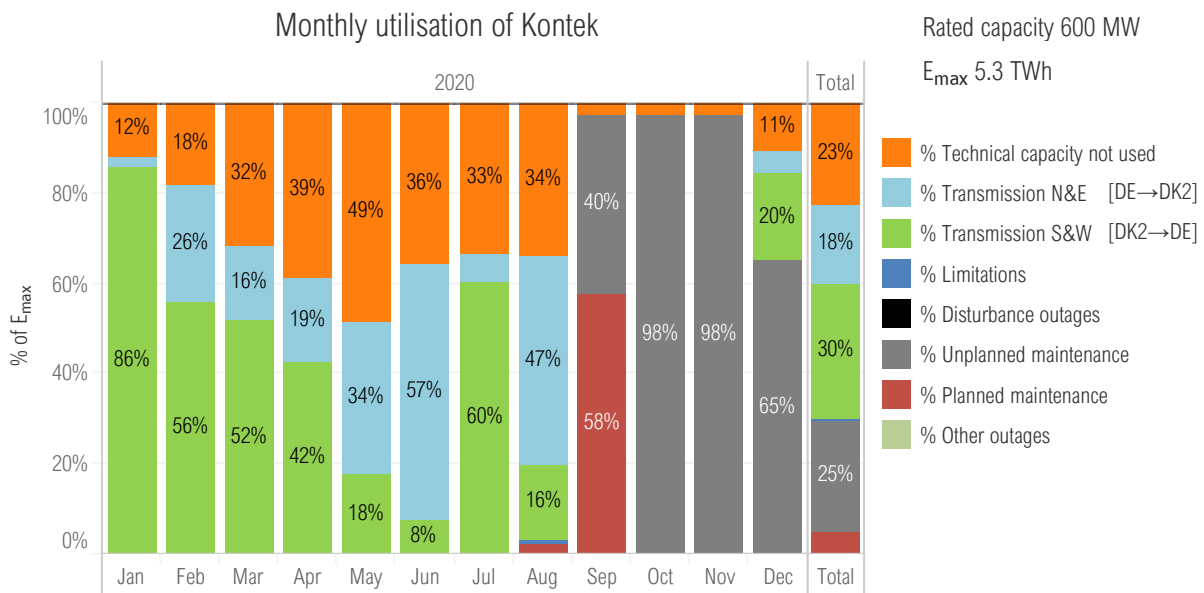

Figure 5.32: Percentage distribution of the availability and utilisation per category according to month for Kontek in 2020. The availability and utilisation categories are defined in detail in Chapter 3.

Table 5.10: Monthly distribution of the technical capacity (E_{max}) for Kontek in 2020. Note that losses are not included in the technical capacity (E_{max}), as is shown in Figure 3.1.

Monthly utilisation of Kontek (South & West direction DK2→DE)		Jan	Feb	Mar	Apr	May	Jun	Jul	Aug	Sep	Oct	Nov	Dec	Total	% total
Technical capacity not used, GWh		53.0	76.6	140.9	168.3	216.8	153.4	149.1	151.3	10.8	11.2	10.8	46.9	1189.0	22.6%
Transmission N&E, GWh		10.2	108.5	73.6	80.8	149.8	245.5	27.3	208.3	-	-	-	22.1	926.2	17.6%
Transmission S&W, GWh		383.2	232.1	231.9	182.9	79.7	33.0	270.0	73.6	-	-	-	87.1	1573.7	29.9%
Limitations, GWh		-	-	-	-	-	-	-	2.7	-	-	-	-	2.7	0.1%
Disturbance outages, GWh		-	0.4	-	-	-	-	-	-	-	-	-	-	0.4	0.0%
Unplanned maintenance., GWh		-	-	-	-	-	-	-	-	172.0	435.2	421.2	290.3	1318.7	25.0%
Planned maintenance, GWh		-	-	-	-	-	-	-	10.5	249.2	-	-	-	259.7	4.9%
Other outages, GWh		-	-	-	-	-	-	-	-	-	-	-	-	-	-
Total, GWh		446.4	417.6	446.4	432.0	446.4	432.0	446.4	446.4	432.0	446.4	432.0	446.4	5270.4	100.0%
Losses SW, GWh		8.5	5.1	4.9	3.8	1.6	0.7	5.8	1.5	-	-	-	1.7	33.5	0.6%
Losses NE, GWh		0.2	2.2	1.4	1.5	2.9	4.9	0.5	4.2	-	-	-	0.5	18.3	0.3%

Figure 5.33 presents the annual utilisation of Kontek per utilisation and unavailability category for the years 2012–2020.

Figure 5.34 presents the percentage of hours of a year Kontek has been affected by either a limitation, a disturbance out-

age, an unplanned or planned maintenance outage or other outage annually during the years 2012–2020. Figure 5.35 presents the annual number of disturbance outages, unplanned and planned maintenance and other outages during the years 2012–2020.

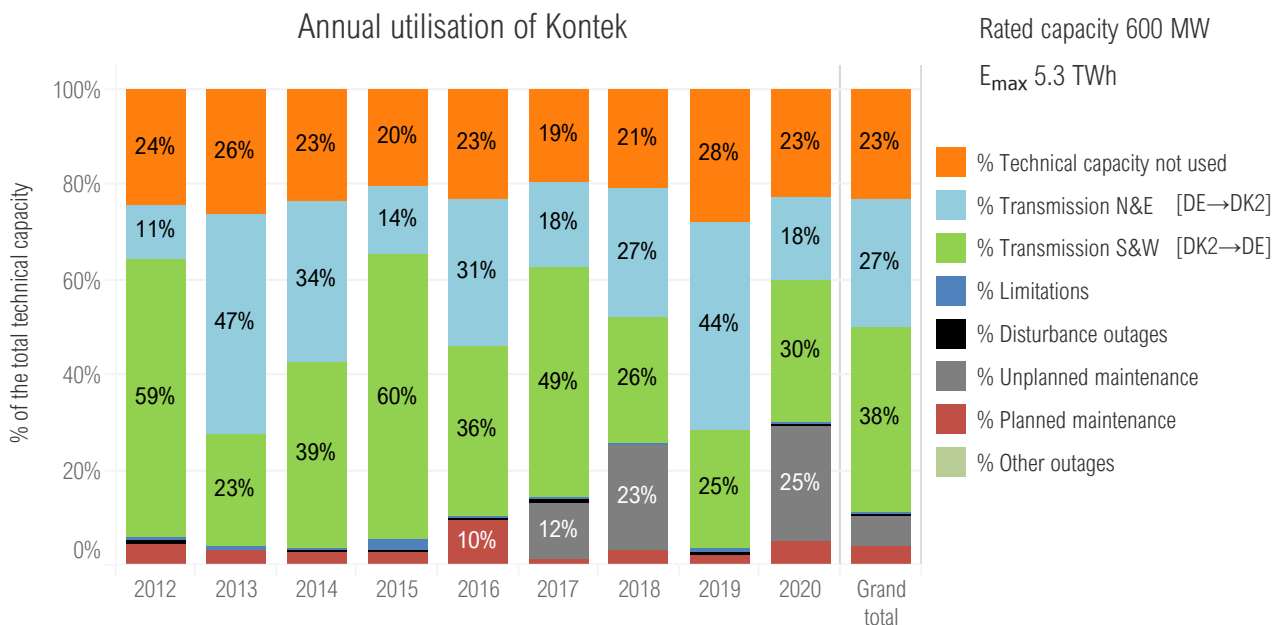

Figure 5.33: Annual utilisation of Kontek according to the utilisation and unavailability categories for the years 2012–2020. The utilisation and unavailability categories are described in more detail in Chapter 3.

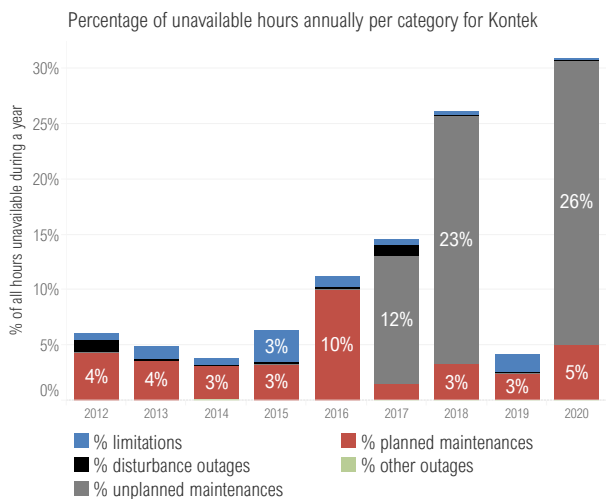

Figure 5.34: Percentage of hours Kontek has been affected by either a limitation, unplanned or planned maintenance or a disturbance or other outage annually for the years 2012–2020. The percentage is calculated by counting the number of hours with a limitation or outage and dividing it by the total number of hours in a year. It should be noted, that any single hour can be affected by both an outage and a limitation.

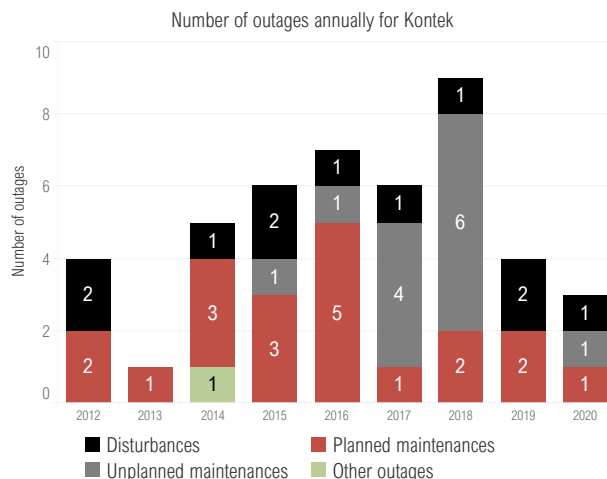

Figure 5.35: The annual number of disturbances, unplanned and planned maintenance outages and other outages for Kontek for the years 2012–2020.

5.3.8 Konti-Skan 1

Figure 5.36 presents the availability and utilisation of Konti-Skan 1 for 2020 and Table 5.11 presents the numerical values behind it. Konti-Skan 1 has been in operation since 1965 and it is connected in south-western Sweden to Lindome (bidding zone SE3) and in Denmark to Vester Hassing (bidding zone DK1).

The rated capacity of Konti-Skan 1 and 2 was updated to 715 MW in both directions on 1 February 2020 (357.5 MW per link). The rated capacity was previously asymmetric depending on the flow direction: 740 MW towards east (370+370) and 680 MW towards west (340+340). The reason of the asymmetric rated capacity was due to historical limitations

and reserve requirements, along with transmission measurements only being done in DK1.

In 2020, Konti-Skan 1 had an available technical capacity of 86 % and the technical capacity not used was 27 %. Totally, 1.1 TWh (35 % of the technical capacity) was transmitted west from Sweden to Denmark and 0.8 TWh (25 % of the technical capacity) was transmitted east to Sweden.

The annual maintenance of Konti-Skan 1 and 2 lasted 6 days in August. Additionally, there were 6 other short planned maintenances primarily for finishing the control system upgrades. Konti-Skan 1 had 4 disturbance outages with minimal impact during 2020.

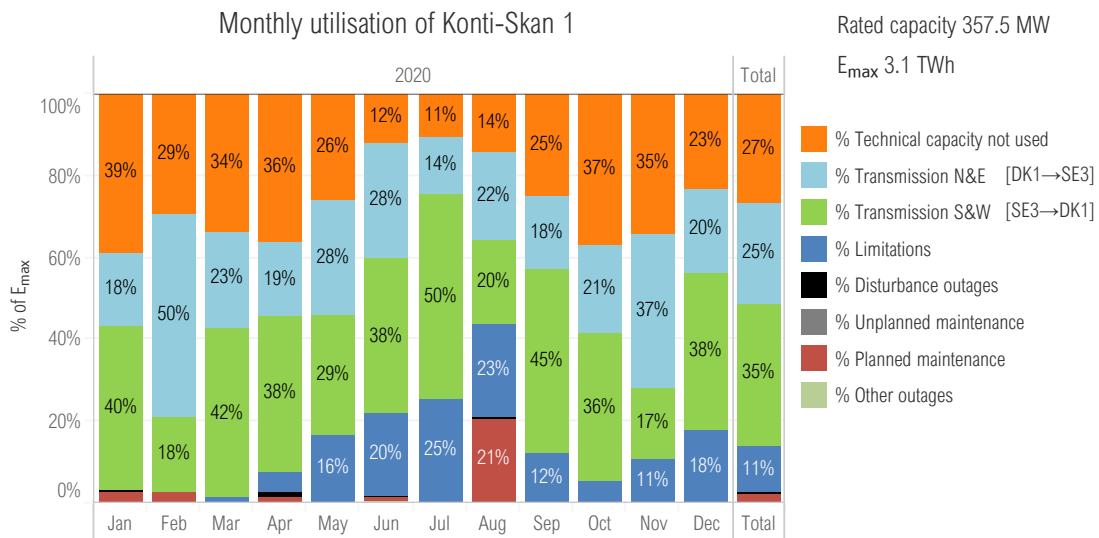

Figure 5.36: Percentage distribution of the availability and utilisation per category according to month for Konti-Skan 1 in 2020. The availability and utilisation categories are defined in detail in Chapter 3.

Table 5.11: Monthly distribution of the technical capacity (E_{max}) for Konti-Skan 1 in 2020. Note that losses are not included in the technical capacity (E_{max}), as is shown in Figure 3.1.

Monthly utilisation of Konti-Skan 1 (South & West direction SE3→DK1)															
	Jan	Feb	Mar	Apr	May	Jun	Jul	Aug	Sep	Oct	Nov	Dec	Total	% total	
Technical capacity not used, GWh	106.7	72.8	90.6	92.5	68.7	30.8	28.5	37.6	64.0	98.7	89.1	62.0	842.1	26.7%	
Transmission N&E, GWh	49.9	123.6	61.1	47.7	75.5	72.1	36.7	57.4	46.1	56.7	96.3	53.9	777.0	24.7%	
Transmission S&W, GWh	110.6	45.8	111.1	97.9	78.3	98.4	133.5	54.4	116.5	96.9	44.0	102.2	1089.6	34.6%	
Limitations, GWh	-	-	3.2	12.0	43.5	52.1	67.3	60.6	30.8	13.7	28.1	48.0	359.3	11.4%	
Disturbance outages, GWh	0.8	-	-	4.1	-	-	-	0.3	-	-	-	-	5.2	0.2%	
Unplanned maintenance, GWh	-	-	-	-	-	-	-	-	-	-	-	-	-	-	
Planned maintenance, GWh	7.2	6.7	-	3.2	-	3.0	-	55.8	-	-	-	-	75.9	2.4%	
Other outages, GWh	-	-	-	-	-	1.1	-	-	-	-	-	-	1.1	0.0%	
Total, GWh	275.3	248.9	266.0	257.5	266.0	257.6	266.0	266.1	257.4	266.0	257.4	266.1	3150.2	100.0%	
Losses SW, GWh	2.3	1.0	2.4	2.1	1.6	2.5	2.8	1.0	2.4	2.0	0.8	2.1	22.9	0.7%	
Losses NE, GWh	1.1	3.0	1.4	1.1	1.8	2.2	1.0	1.6	1.1	1.4	2.2	1.2	19.2	0.6%	

Figure 5.37 presents the annual utilisation of Konti-Skan 1 per utilisation and unavailability category for the years 2012–2020.

Figure 5.38 presents the percentage of hours of a year Konti-Skan 1 has been affected by either a limitation, a distur-

bance outage, an unplanned or planned maintenance outage or other outage annually during the years 2012–2020. Figure 5.39 presents the annual number of disturbance outages, unplanned and planned maintenance and other outages during the years 2012–2020.

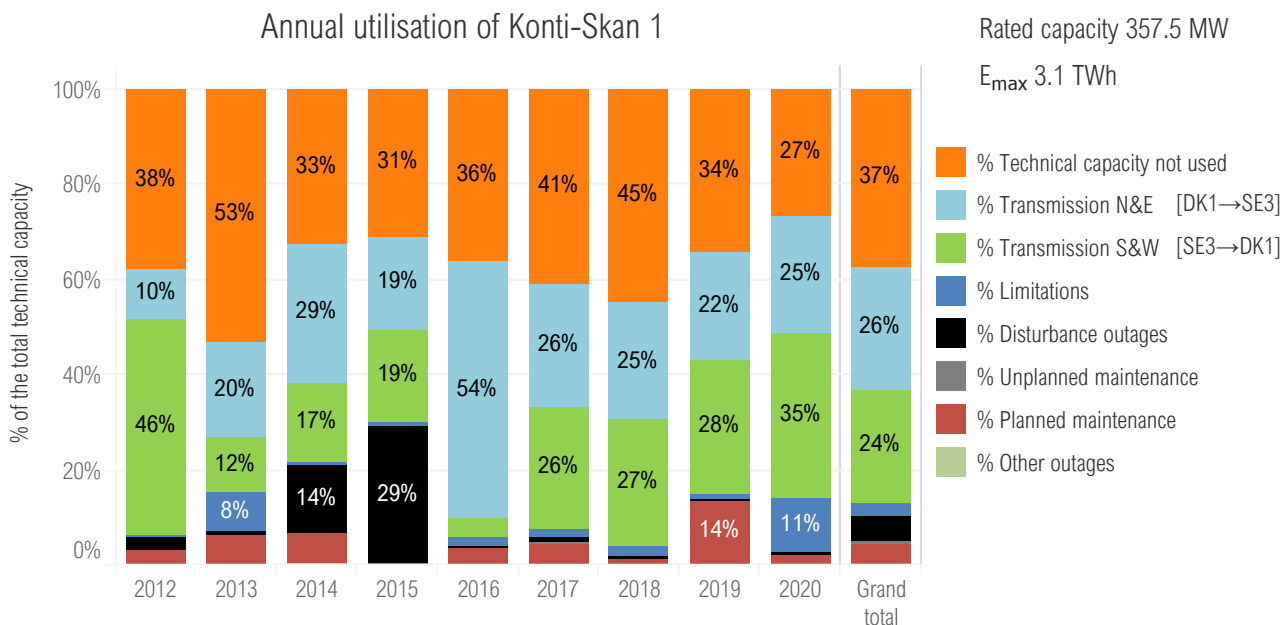

Figure 5.37: Annual utilisation of Konti-Skan 1 according to the utilisation and unavailability categories for the years 2012–2020. The utilisation and unavailability categories are described in more detail in Chapter 3.

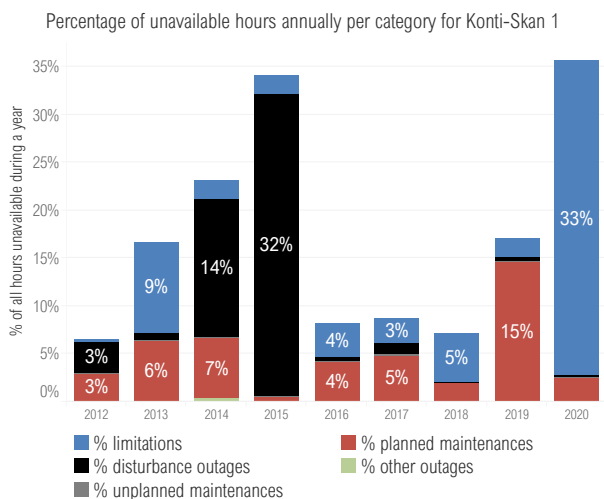

Figure 5.38: Percentage of hours Konti-Skan 1 has been affected by either a limitation, unplanned or planned maintenance or a disturbance or other outage annually for the years 2012–2020. The percentage is calculated by counting the number of hours with a limitation or outage and dividing it by the total number of hours in a year. It should be noted, that any single hour can be affected by both an outage and a limitation.

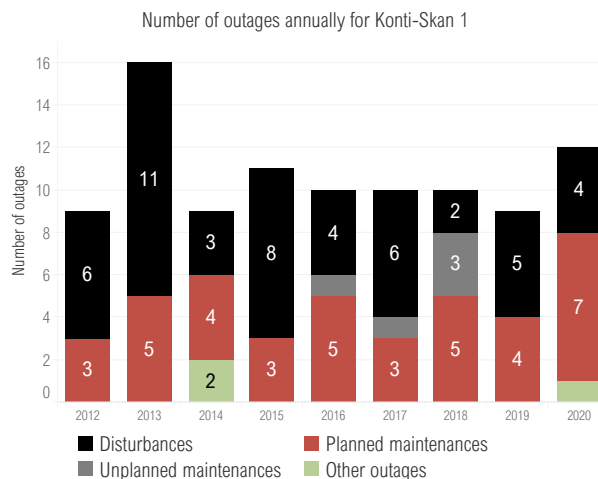

Figure 5.39: The annual number of disturbances, unplanned and planned maintenance outages and other outages for Konti-Skan 1 for the years 2012–2020.

5.3.9 Konti-Skan 2

Figure 5.40 presents the availability and utilisation of Konti-Skan 2 for 2020 and Table 5.12 presents the numerical values behind it. Konti-Skan 2 is connected between Sweden and Denmark in parallel to Konti-Skan 1 and has been in operation since 1988.

The rated capacity of Konti-Skan 1 and 2 was updated to 715 MW in both directions on 1 February 2020 (357.5 MW per link). The rated capacity was previously asymmetric depending on the flow direction: 740 MW towards east (370+370) and 680 MW towards west (340+340). The reason of the asymmetric rated capacity was due to historical limitations and reserve requirements, along with transmission measure-

ments only being done in DK1.

In 2020, Konti-Skan 2 had an available technical capacity of 81 % and the technical capacity not used was 25 %. Totally, 1.0 TWh (33 % of the technical capacity) was transmitted west from Sweden to Denmark and 0.7 TWh (23 % of the technical capacity) was transmitted east to Sweden.

The annual maintenance of Konti-Skan 1 and 2 lasted 6 days in August. Additionally, there were 6 other short planned maintenances primarily for finishing the control system upgrades. Konti-Skan 2 had 4 disturbance outages during 2020, of which one was substantial and lasted 20 days due to a fault in the smoothing reactor.

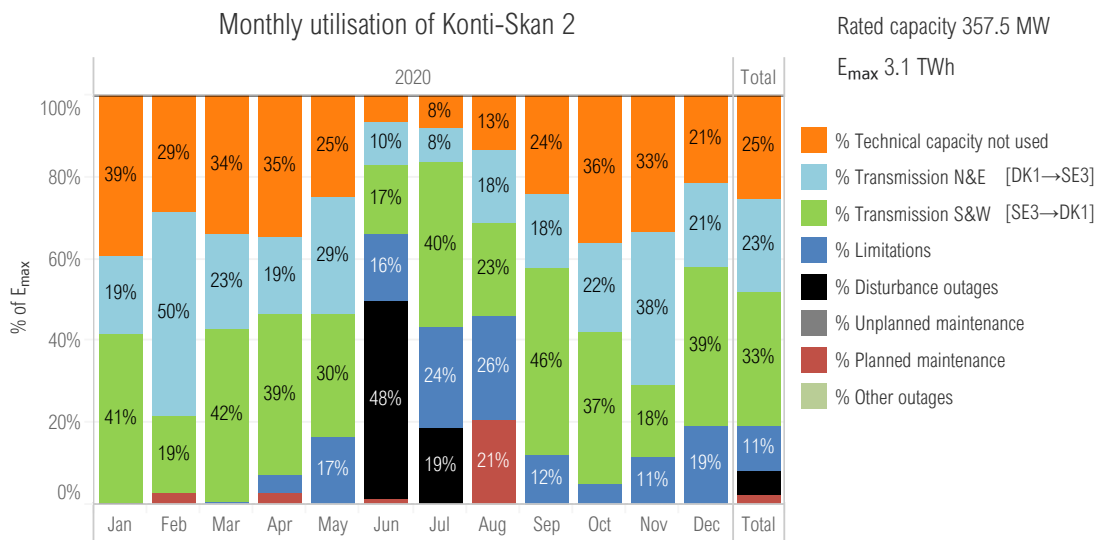

Figure 5.40: Percentage distribution of the availability and utilisation per category according to month for Konti-Skan 2 in 2020. The availability and utilisation categories are defined in detail in Chapter 3.

Table 5.12: Monthly distribution of the technical capacity (E_{max}) for Konti-Skan 2 in 2020. Note that losses are not included in the technical capacity (E_{max}), as is shown in Figure 3.1.

	Jan	Feb	Mar	Apr	May	Jun	Jul	Aug	Sep	Oct	Nov	Dec	Total	% total
Technical capacity not used, GWh	108.2	71.3	90.2	89.9	66.1	17.2	21.4	35.3	61.7	95.9	85.7	57.0	799.7	25.4%
Transmission N&E, GWh	52.7	123.8	62.1	48.3	76.4	26.3	22.5	47.9	47.0	58.2	97.2	55.1	717.5	22.8%
Transmission S&W, GWh	112.8	46.6	112.3	101.3	79.3	44.3	107.3	60.0	117.5	98.7	45.2	103.3	1028.7	32.7%
Limitations, GWh	-	-	1.6	11.6	44.3	42.1	64.8	67.9	30.6	13.2	29.4	50.7	356.4	11.3%
Disturbance outages, GWh	1.6	-	-	-	-	124.6	49.9	-	0.6	-	-	-	176.7	5.6%
Unplanned maintenance, GWh	-	-	-	-	-	-	-	-	-	-	-	-	-	-
Planned maintenance, GWh	-	7.1	-	6.4	-	3.0	-	54.8	-	-	-	-	71.3	2.3%
Other outages, GWh	-	-	-	-	-	-	-	-	-	-	-	-	-	-
Total, GWh	275.3	248.9	266.2	257.5	266.1	257.4	266.0	266.0	257.4	266.0	257.4	266.1	3150.2	100.0%
Losses SW, GWh	2.6	1.1	2.6	2.3	1.6	0.8	2.1	1.2	2.5	2.1	0.9	2.3	22.3	0.7%
Losses NE, GWh	1.3	3.2	1.5	1.2	1.9	0.7	0.6	1.2	1.2	1.5	2.5	1.3	18.1	0.6%

Figure 5.41 presents the annual utilisation of Konti-Skan 2 per utilisation and unavailability category for the years 2012–2020.

Figure 5.42 presents the percentage of hours of a year Konti-Skan 2 has been affected by either a limitation, a distur-

bance outage, an unplanned or planned maintenance outage or other outage annually during the years 2012–2020. Figure 5.43 presents the annual number of disturbance outages, unplanned and planned maintenance and other outages during the years 2012–2020.

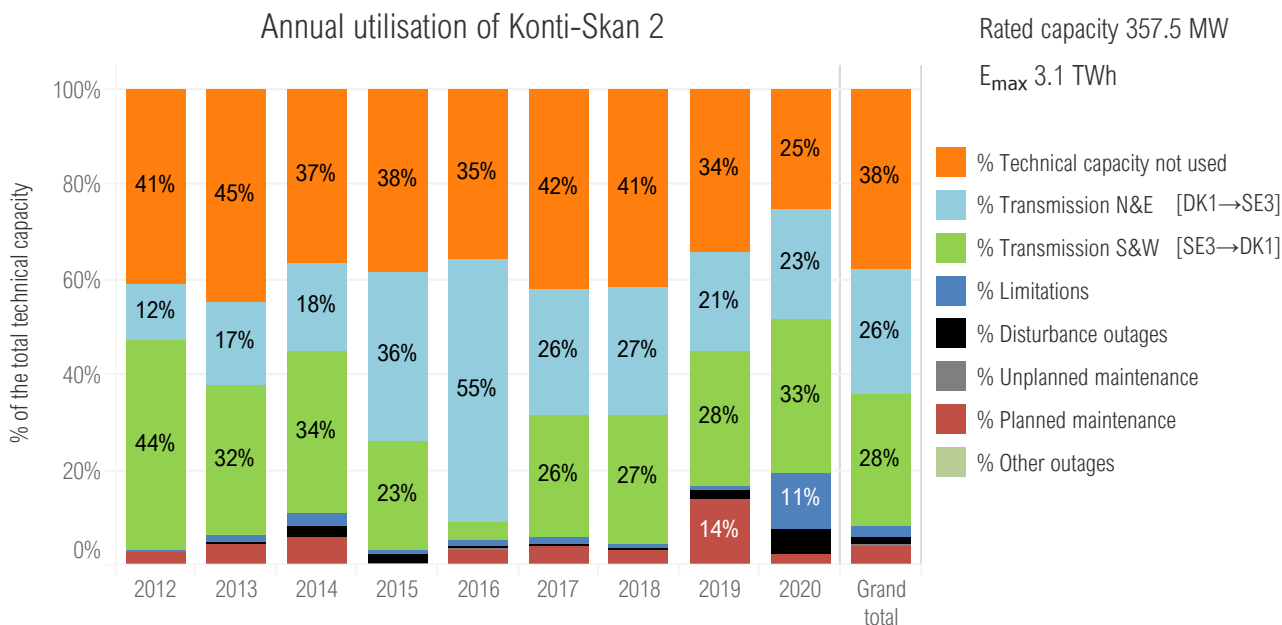

Figure 5.41: Annual utilisation of Konti-Skan 2 according to the utilisation and unavailability categories for the years 2012–2020. The utilisation and unavailability categories are described in more detail in Chapter 3.

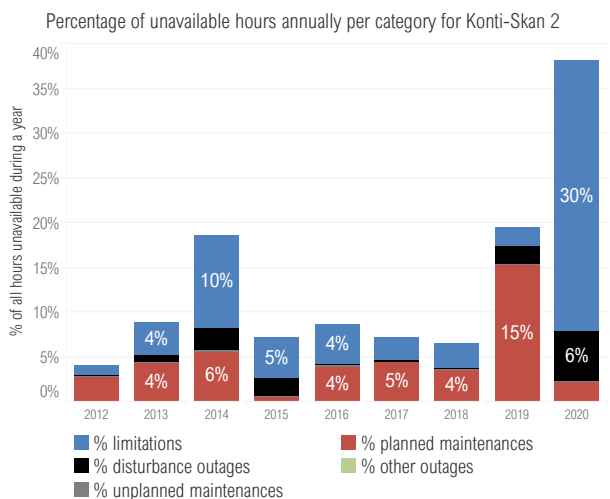

Figure 5.42: Percentage of hours Konti-Skan 2 has been affected by either a limitation, unplanned or planned maintenance or a disturbance or other outage annually for the years 2012–2020. The percentage is calculated by counting the number of hours with a limitation or outage and dividing it by the total number of hours in a year. It should be noted, that any single hour can be affected by both an outage and a limitation.

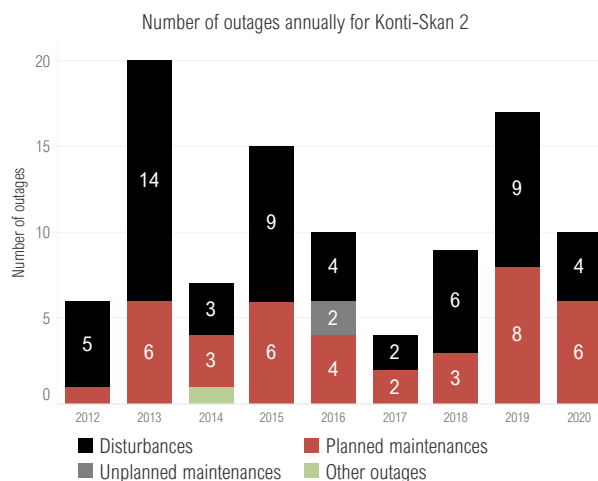

Figure 5.43: The annual number of disturbances, unplanned and planned maintenance outages and other outages for Konti-Skan 2 for the years 2012–2020.

5.3.10 LitPol Link

Figure 5.44 presents the availability and utilisation of LitPol Link for 2020 and Table 4.1 presents the numerical values behind it. LitPol Link has been in operation since the end of 2015. In Lithuania, it is connected to Alytus (bidding zone LT) and in Poland to Elk (bidding zone PL). The transmission capacity of LitPol Link is 500 MW.

In 2020, LitPol Link had an available technical capacity of 91 %. The technical capacity not used was 33 %. Totally,

2.2 TWh (50 % of the technical capacity) as transmitted west from Lithuania to Poland and 0.4 TWh (9 % of the technical capacity) was transmitted east to Lithuania.

The annual maintenance of LitPol Link lasted 23 days starting from late September. LitPol Link had in addition 9 other planned maintenance outages, 6 unplanned maintenance outages, and 2 disturbance outages with minimal impact in 2020.

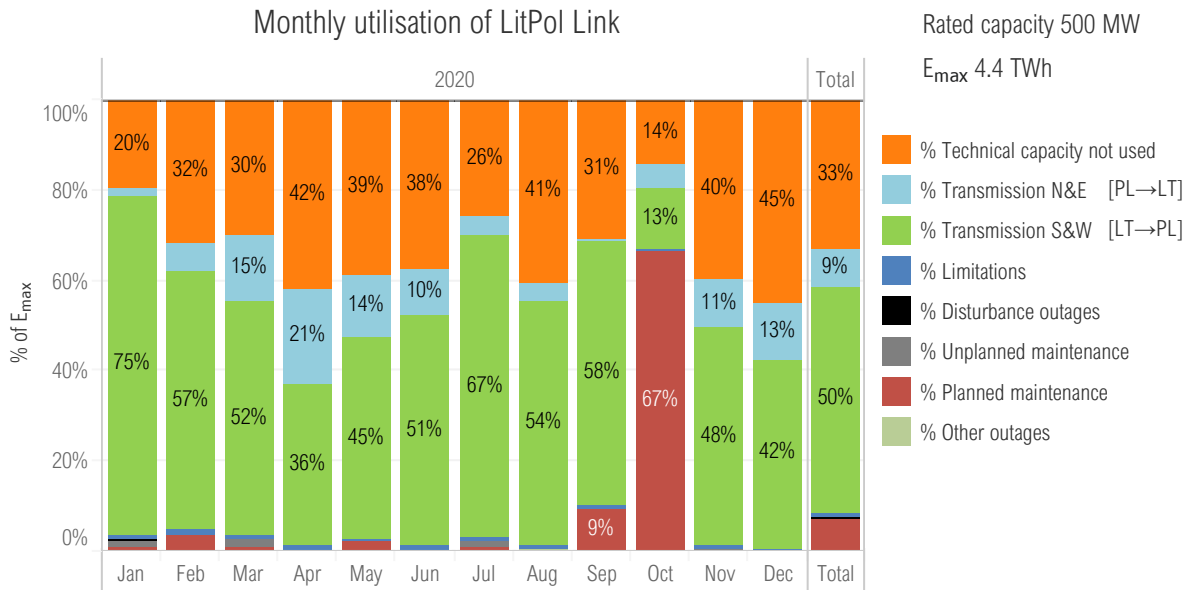

Figure 5.44: Percentage distribution of the availability and utilisation per category according to month for LitPol Link in 2020. The availability and utilisation categories are defined in detail in Chapter 3.

Table 5.13: Monthly distribution of the technical capacity (E_{max}) for LitPol Link in 2020. Note that losses are not included in the technical capacity (E_{max}), as is shown in Figure 3.1.

Monthly utilisation of LitPol Link (South & West direction LT→PL)														Total	% total
	Jan	Feb	Mar	Apr	May	Jun	Jul	Aug	Sep	Oct	Nov	Dec			
Technical capacity not used, GWh	73.7	110.7	111.1	150.7	145.2	135.6	96.5	151.1	111.6	53.1	143.3	168.4	1451.0	33.0%	
Transmission N&E, GWh	6.4	21.0	54.8	75.2	50.4	37.2	15.4	15.2	1.3	19.3	37.8	46.6	380.7	8.7%	
Transmission S&W, GWh	277.9	199.1	192.2	128.9	166.5	182.6	248.6	201.0	209.4	49.7	173.9	154.7	2184.7	49.7%	
Limitations, GWh	4.7	4.6	3.2	5.2	2.4	4.1	3.9	2.8	4.2	0.8	2.7	2.3	41.1	0.9%	
Disturbance outages, GWh	1.3	-	-	-	-	-	-	-	-	-	-	-	1.3	0.0%	
Unplanned maintenance., GWh	5.1	-	6.5	-	-	-	4.0	-	-	-	2.2	-	17.8	0.4%	
Planned maintenance, GWh	3.0	12.5	4.1	-	7.5	-	3.5	-	33.5	249.0	-	-	313.1	7.1%	
Other outages, GWh	-	-	-	-	-	0.4	-	1.8	-	-	-	-	2.3	0.1%	
Total, GWh	372.0	348.0	372.0	360.0	372.0	360.0	372.0	372.0	360.0	372.0	360.0	372.0	4392.0	100.0%	
Losses SW, GWh	4.0	3.0	2.9	2.0	2.6	2.9	3.6	3.1	3.3	0.8	2.7	2.4	33.4	0.8%	
Losses NE, GWh	0.1	0.4	0.9	1.3	0.9	0.6	0.3	0.3	-	0.3	0.6	0.9	6.8	0.2%	

Figure 5.45 presents the annual utilisation of LitPol Link per utilisation and unavailability category for the years 2016–2020.

Figure 5.46 presents the percentage of hours of a year LitPol Link has been affected by either a limitation, a distur-

bance outage, an unplanned or planned maintenance outage or other outage annually during the years 2016–2020. Figure 5.47 presents the annual number of disturbance outages, unplanned and planned maintenance and other outages during the years 2016–2020.

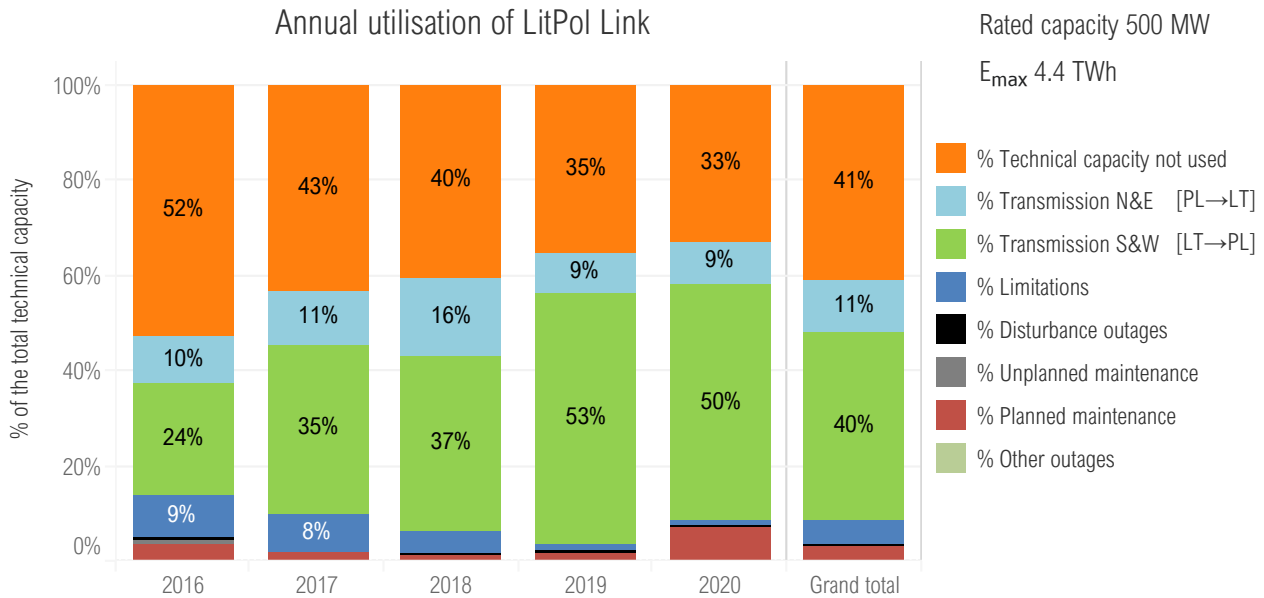

Figure 5.45: Annual utilisation of LitPol Link according to the utilisation and unavailability categories for the years 2016–2020. The utilisation and unavailability categories are described in more detail in Chapter 3.

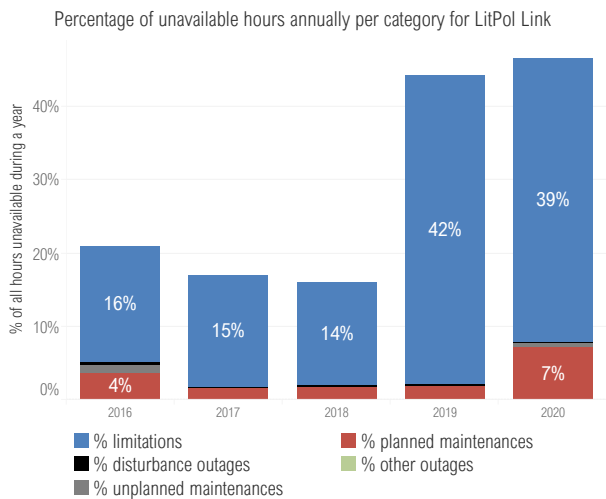

Figure 5.46: Percentage of hours LitPol Link has been affected by either a limitation, unplanned or planned maintenance or a disturbance or other outage annually for the years 2016–2020. The percentage is calculated by counting the number of hours with a limitation or outage and dividing it by the total number of hours in a year. It should be noted, that any single hour can be affected by both an outage and a limitation.

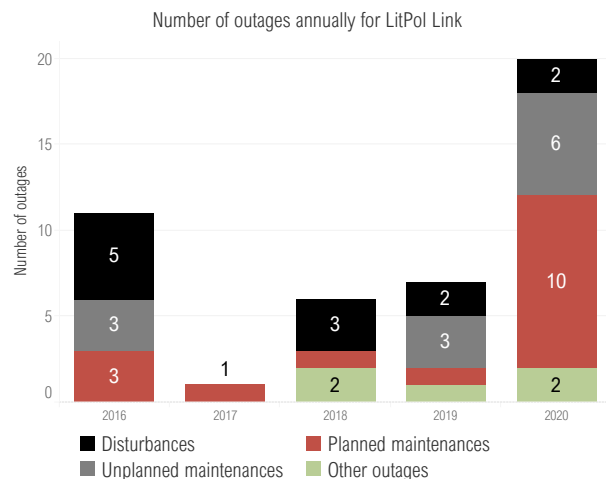

Figure 5.47: The annual number of disturbances, unplanned and planned maintenance outages and other outages for LitPol Link for the years 2016–2020.

5.3.11 NordBalt

Figure 5.48 presents the availability and utilisation of NordBalt for 2020 and Table 5.14 presents the numerical values behind it. NordBalt has been in operation since 2016. In Sweden, it is connected to Nybro (bidding zone SE4) and in Lithuania to Klaipeda (bidding zone LT). The transmission capacity of NordBalt is 700 MW at the receiving end.

In 2020, NordBalt had an available technical capacity of 98 %. The technical capacity not used was 22 %. Totally, 4.6 TWh

(75 % of the technical capacity) was transmitted south from Sweden to Lithuania and 0.1 TWh (2 % of the technical capacity) was transmitted north to Sweden.

The annual maintenance of NordBalt lasted 5 days in October. Additionally, NordBalt had 1 short planned maintenance, 2 disturbance outages (one lasting 9 days in June and the other 2 days in December) and 1 other outage with minimal impact during 2020.

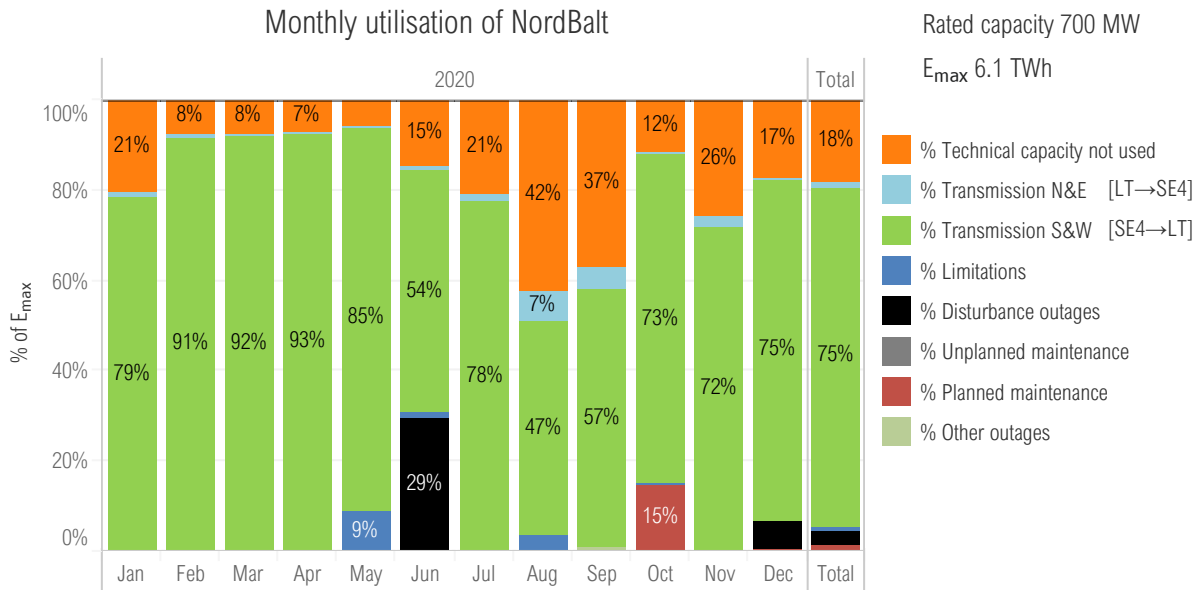

Figure 5.48: Percentage distribution of the availability and utilisation per category according to month for NordBalt in 2020. The availability and utilisation categories are defined in detail in Chapter 3.

Table 5.14: Monthly distribution of the technical capacity (E_{max}) for NordBalt in 2020. Note that losses are not included in the technical capacity (E_{max}), as is shown in Figure 3.1.

Monthly utilisation of NordBalt (South & West direction SE4→LT)															
	Jan	Feb	Mar	Apr	May	Jun	Jul	Aug	Sep	Oct	Nov	Dec	Total	% total	
Technical capacity not used, GWh	107.4	36.9	39.9	36.9	30.1	75.0	110.0	220.2	187.7	60.3	129.8	90.4	1124.4	18.3%	
Transmission N&E, GWh	4.3	5.0	2.9	0.1	0.3	3.6	5.6	35.7	22.8	2.0	10.9	3.6	96.8	1.6%	
Transmission S&W, GWh	409.1	445.3	478.0	467.1	444.4	271.0	404.2	246.2	289.6	380.5	363.3	391.2	4589.8	74.6%	
Limitations, GWh	-	-	-	-	46.1	6.1	1.1	18.8	-	1.7	-	-	73.7	1.2%	
Disturbance outages, GWh	-	-	-	-	-	148.3	-	-	-	-	-	33.6	181.9	3.0%	
Unplanned maintenance, GWh	-	-	-	-	-	-	-	-	-	-	-	-	-	-	
Planned maintenance, GWh	-	-	-	-	-	-	-	-	-	76.3	-	2.0	78.3	1.3%	
Other outages, GWh	-	-	-	-	-	-	-	-	3.9	-	-	-	3.9	0.1%	
Total, GWh	520.8	487.2	520.8	504.0	520.8	504.0	520.8	520.8	504.0	520.8	504.0	520.8	6148.8	100.0%	
Losses SW, GWh	18.3	21.0	22.5	21.8	20.0	12.2	18.2	10.3	12.4	17.6	16.2	18.0	208.4	3.4%	
Losses NE, GWh	0.1	0.2	0.1	-	-	0.1	0.2	1.2	0.9	0.1	0.4	0.1	3.4	0.1%	

Figure 5.49 presents the annual utilisation of NordBalt per utilisation and unavailability category for the years 2016–2020.

Figure 5.50 presents the percentage of hours of a year NordBalt has been affected by either a limitation, a disturbance

outage, an unplanned or planned maintenance outage or other outage annually during the years 2016–2020. Figure 5.51 presents the annual number of disturbance outages, unplanned and planned maintenance and other outages during the years 2016–2020.

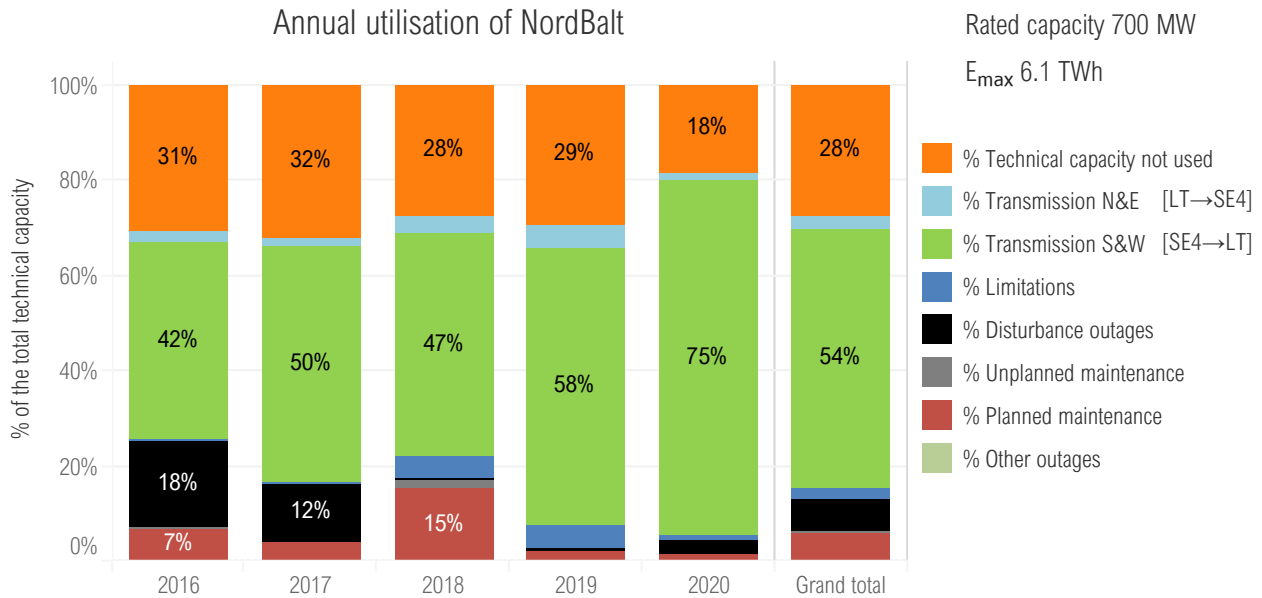

Figure 5.49: Annual utilisation of NordBalt according to the utilisation and unavailability categories for the years 2016–2020. The utilisation and unavailability categories are described in more detail in Chapter 3.

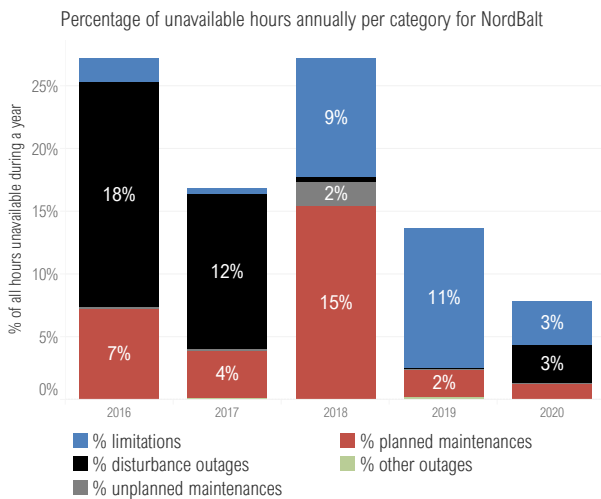

Figure 5.50: Percentage of hours NordBalt has been affected by either a limitation, unplanned or planned maintenance or a disturbance or other outage annually for the years 2016–2020. The percentage is calculated by counting the number of hours with a limitation or outage and dividing it by the total number of hours in a year. It should be noted, that any single hour can be affected by both an outage and a limitation.

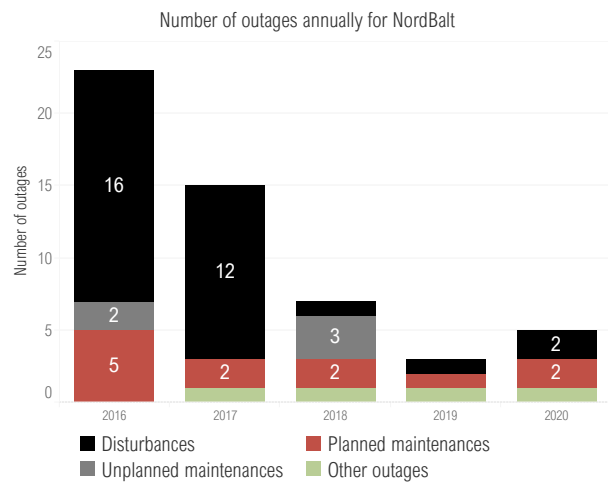

Figure 5.51: The annual number of disturbances, unplanned and planned maintenance outages and other outages for NordBalt for the years 2016–2020.

5.3.12 NorNed

Figure 5.52 presents the availability and utilisation of NorNed for 2020 and Table 5.15 presents the numerical values behind it. NorNed has been in operation since 2008, and is, with a length of 580 km, the longest HVDC link connected to the Nordic power system. In Norway on the south-western coast (bidding zone NO2) it is connected to Feda substation and in Netherlands to Eemshaven (bidding zone APX NL). The transmission capacity of NorNed is 700 MW.

In 2020, NorNed had an available technical capacity of 83 %. The technical capacity not used was 6 %. Totally, 4.6 TWh (75 % of the technical capacity) was transmitted south from Norway to Netherlands and 0.1 TWh (2 % of the technical capacity) was transmitted north to Norway.

NorNed had no annual maintenance during 2020, but 3 planned maintenance outages due to AC filters problems in Holland. The limitations were also due to the AC filters.

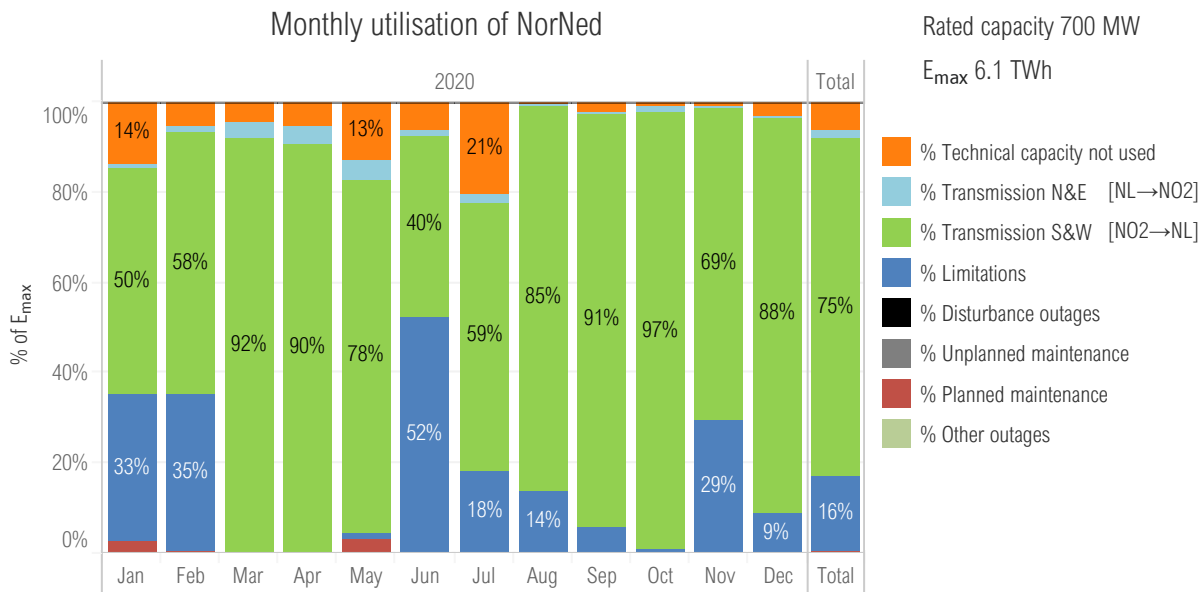

Figure 5.52: Percentage distribution of the availability and utilisation per category according to month for NorNed in 2020. The availability and utilisation categories are defined in detail in Chapter 3.

Table 5.15: Monthly distribution of the technical capacity (E_{max}) for NorNed in 2020. Note that losses are not included in the technical capacity (E_{max}), as is shown in Figure 3.1.

Monthly utilisation of NorNed (South & West direction NO2→NL)														Total	% total
	Jan	Feb	Mar	Apr	May	Jun	Jul	Aug	Sep	Oct	Nov	Dec			
Technical capacity not used, GWh	71.3	25.2	23.4	27.7	66.5	31.7	107.5	2.9	11.6	5.8	4.1	15.6	393.3	6.4%	
Transmission N&E, GWh	5.4	7.5	19.0	20.7	24.7	7.6	9.8	0.7	2.6	4.9	2.4	0.1	105.4	1.7%	
Transmission S&W, GWh	259.6	281.8	479.8	456.9	406.8	200.5	309.4	445.7	462.0	507.7	349.8	460.1	4620.2	75.0%	
Limitations, GWh	171.5	171.1	-	-	6.7	264.2	94.7	72.6	29.0	3.5	147.7	47.1	1008.1	16.4%	
Disturbance outages, GWh	-	-	-	-	-	-	-	-	-	-	-	-	-	-	
Unplanned maintenance, GWh	-	-	-	-	-	-	-	-	-	-	-	-	-	-	
Planned maintenance, GWh	12.9	1.7	-	-	17.2	-	-	-	-	-	-	-	31.8	0.5%	
Other outages, GWh	-	-	-	-	-	-	-	-	-	-	-	-	-	-	
Total, GWh	520.8	487.3	522.3	505.4	522.0	504.0	521.4	521.9	505.1	521.9	504.0	522.8	6158.8	100.0%	
Losses SW, GWh	7.2	8.0	19.0	18.0	16.0	4.7	11.2	16.9	18.1	20.3	10.5	17.3	167.3	2.7%	
Losses NE, GWh	0.2	0.2	0.7	0.8	0.9	0.3	0.4	-	0.1	0.2	0.1	-	4.0	0.1%	

Figure 5.53 presents the annual utilisation of NorNed per utilisation and unavailability category for the years 2012–2020.

Figure 5.54 presents the percentage of hours of a year NorNed has been affected by either a limitation, a disturbance out-

age, an unplanned or planned maintenance outage or other outage annually during the years 2012–2020. Figure 5.55 presents the annual number of disturbance outages, unplanned and planned maintenance and other outages during the years 2012–2020.

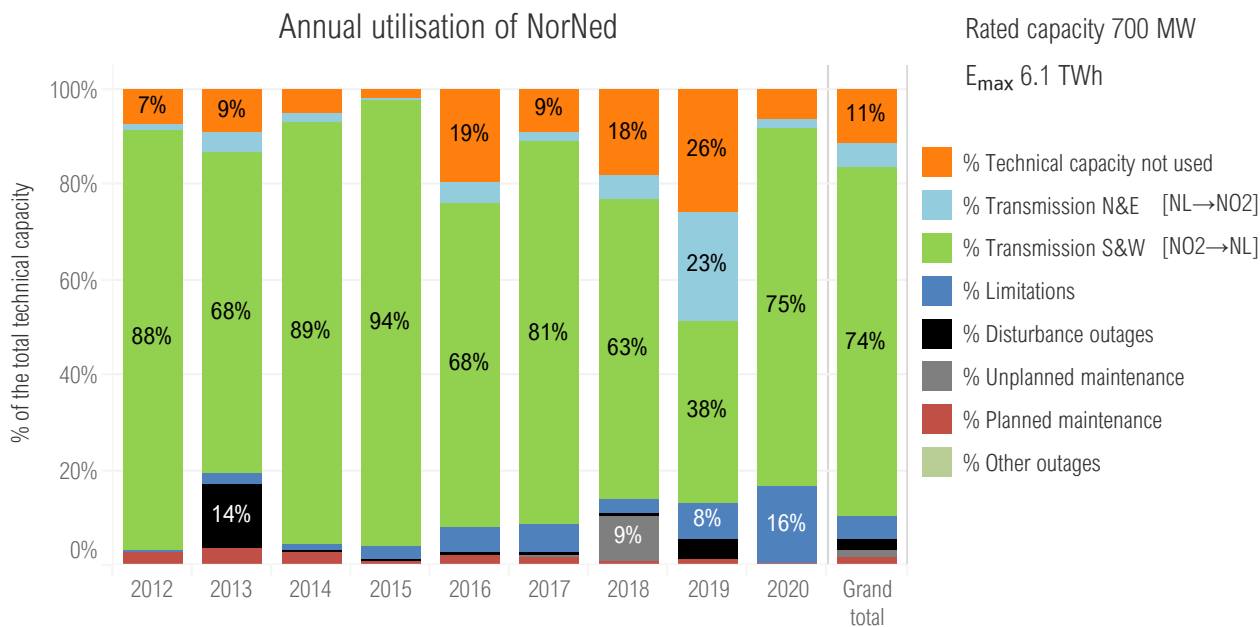

Figure 5.53: Annual utilisation of NorNed according to the utilisation and unavailability categories for the years 2012–2020. The utilisation and unavailability categories are described in more detail in Chapter 3.

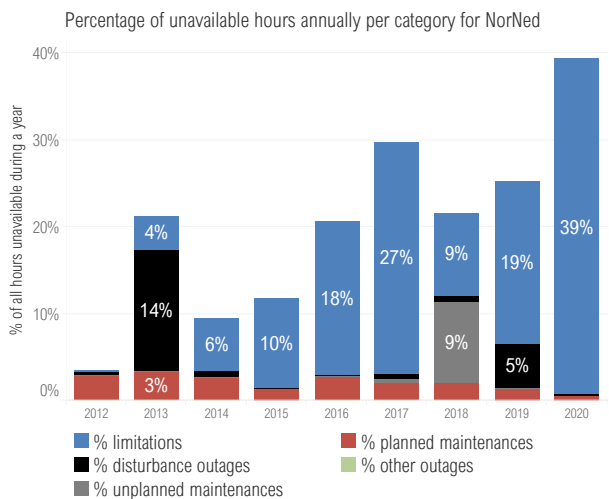

Figure 5.54: Percentage of hours NorNed has been affected by either a limitation, unplanned or planned maintenance or a disturbance or other outage annually for the years 2012–2020. The percentage is calculated by counting the number of hours with a limitation or outage and dividing it by the total number of hours in a year. It should be noted, that any single hour can be affected by both an outage and a limitation.

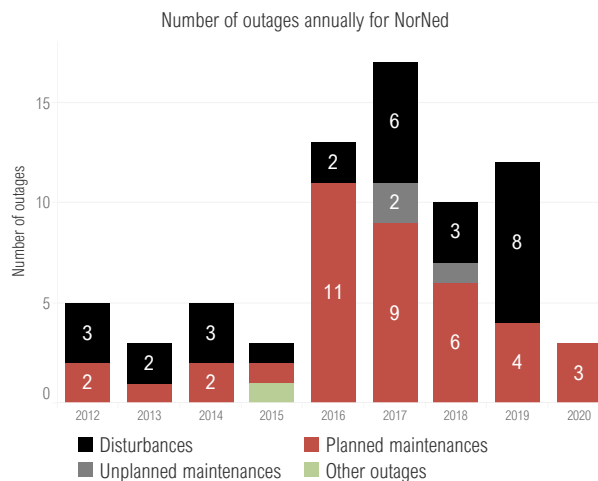

Figure 5.55: The annual number of disturbances, unplanned and planned maintenance outages and other outages for NorNed for the years 2012–2020.

5.3.13 Skagerrak 1

Figure 5.56 presents the availability and utilisation of Skagerrak 1 for 2020 and Table 5.16 presents the numerical values behind it. Skagerrak 1 and Skagerrak 2 have been in operation since 1976 and are the oldest HVDC links in operation in the Nordic countries. In Norway, the links are connected to Kristiansand on the southern coast (bidding zone NO2) and in Denmark to Tjele (bidding zone DK1), 15 km east of the town of Viborg in the northern part of Jutland. The transmission capacity is 236 MW at the receiving end.

In 2020, Skagerrak 1 had an available technical capacity of 66 %. The technical capacity not used was 25 %. Totally, 0.7 TWh (38 % of the technical capacity) was transmitted south from Norway to the Denmark and 0.1 TWh (3 % of the technical capacity) was transmitted north to Norway.

There was no annual maintenance of Skagerrak 1, but one

other planned maintenance outage of Skagerrak 1–3 due to reconstruction work in Kristiansand in October. Skagerrak 1 had 1 major and 4 minor disturbance outages and 1 minor unplanned maintenance outage during 2020. The severe disturbance outage lasted 88 days and was caused by a submarine cable fault due to a ship.

Skagerrak 1, 2, 3 and 4 have been limited due to “careful operation” since the Skagerrak 4 cable faults in December 2019. In 2020, the capacity was prioritised followingly:

- 1.1–16.3 North direction prioritised
- 16.3–18.3 Discharge of Skagerrak 4 before switching polarity
- 18.3–31.12 South direction prioritised

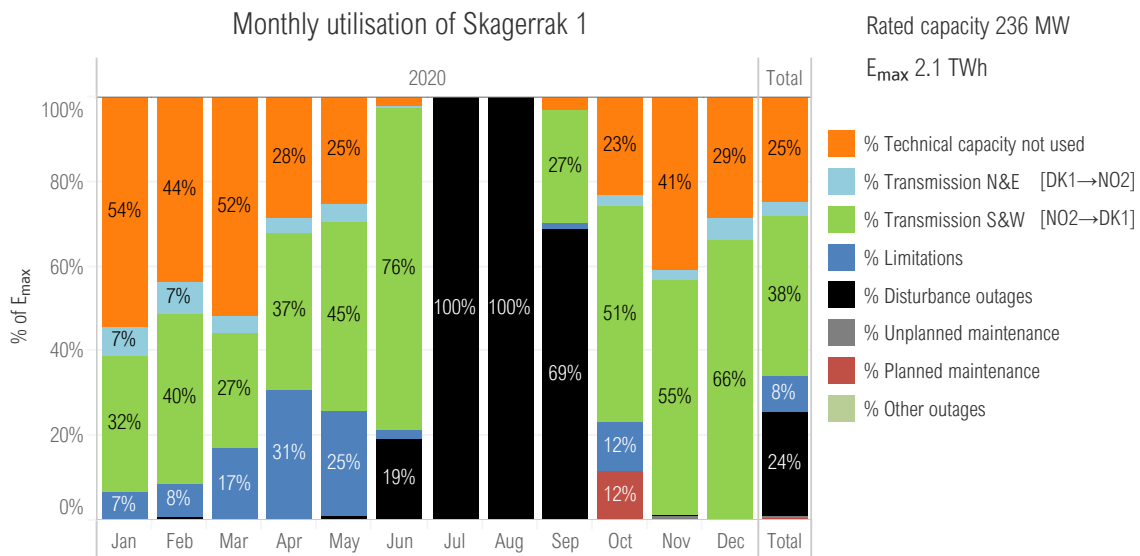

Figure 5.56: Percentage distribution of the availability and utilisation per category according to month for Skagerrak 1 in 2020. The availability and utilisation categories are defined in detail in Chapter 3.

Table 5.16: Monthly distribution of the technical capacity (E_{max}) for Skagerrak 1 in 2020. Note that losses are not included in the technical capacity (E_{max}), as is shown in Figure 3.1.

Monthly utilisation of Skagerrak 1 (South & West direction NO2→DK1)	Jan	Feb	Mar	Apr	May	Jun	Jul	Aug	Sep	Oct	Nov	Dec	Total	% total
Technical capacity not used, GWh	95.7	72.2	90.9	48.4	44.6	4.0	-	-	5.4	40.6	69.9	50.3	521.9	25.2%
Transmission N&E, GWh	11.8	12.3	7.1	6.6	7.4	0.9	-	-	-	5.0	3.9	8.9	63.8	3.1%
Transmission S&W, GWh	56.2	65.5	48.1	62.3	78.3	128.8	-	-	45.6	89.4	94.3	116.4	784.9	37.9%
Limitations, GWh	11.9	12.5	29.5	52.7	43.6	3.3	-	-	2.3	20.3	-	-	176.0	8.5%
Disturbance outages, GWh	-	1.8	-	-	1.7	33.0	175.6	175.6	116.9	-	0.8	-	505.3	24.4%
Unplanned maintenance, GWh	-	-	-	-	-	-	-	-	-	-	1.2	-	1.2	0.1%
Planned maintenance, GWh	-	-	-	-	-	-	-	-	-	20.2	-	-	20.2	1.0%
Other outages, GWh	-	-	-	-	-	-	-	-	-	-	-	-	-	-
Total, GWh	175.6	164.3	175.6	169.9	175.6	169.9	175.6	175.6	170.1	175.6	169.9	175.6	2073.3	100.0%
Losses SW, GWh	2.9	3.5	2.2	2.5	3.5	6.2	-	-	2.4	4.3	4.7	5.8	38.2	1.8%
Losses NE, GWh	0.5	0.5	0.3	0.4	0.4	-	-	-	-	0.2	0.2	0.4	2.8	0.1%

Figure 5.57 presents the annual utilisation of Skagerrak 1 per utilisation and unavailability category for the years 2012–2020.

Figure 5.58 presents the percentage of hours of a year Skagerrak 1 has been affected by either a limitation, a distur-

bance outage, an unplanned or planned maintenance outage or other outage annually during the years 2012–2020. Figure 5.59 presents the annual number of disturbance outages, unplanned and planned maintenance and other outages during the years 2012–2020.

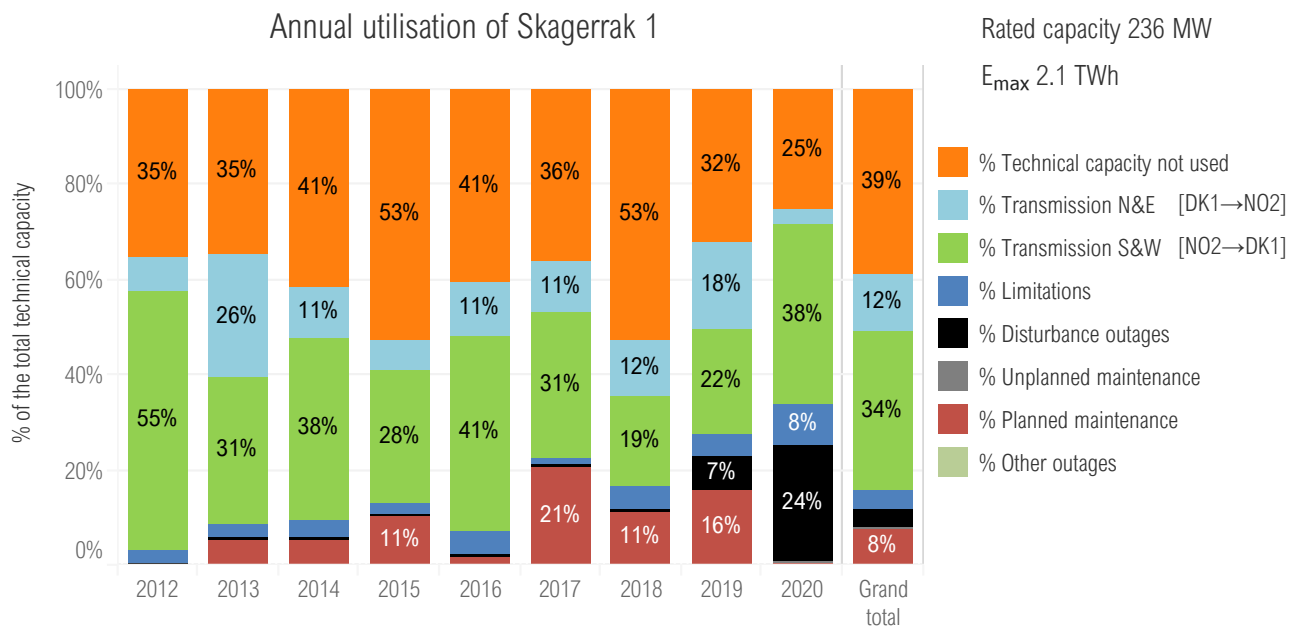

Figure 5.57: Annual utilisation of Skagerrak 1 according to the utilisation and unavailability categories for the years 2012–2020. The utilisation and unavailability categories are described in more detail in Chapter 3.

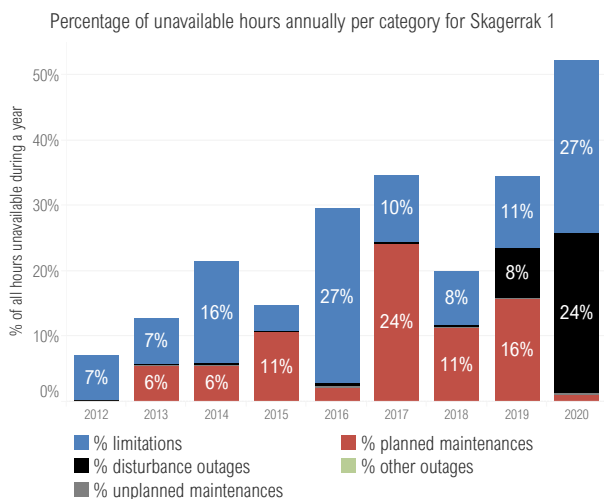

Figure 5.58: Percentage of hours Skagerrak 1 has been affected by either a limitation, unplanned or planned maintenance or a disturbance or other outage annually for the years 2012–2020. The percentage is calculated by counting the number of hours with a limitation or outage and dividing it by the total number of hours in a year. It should be noted, that any single hour can be affected by both an outage and a limitation.

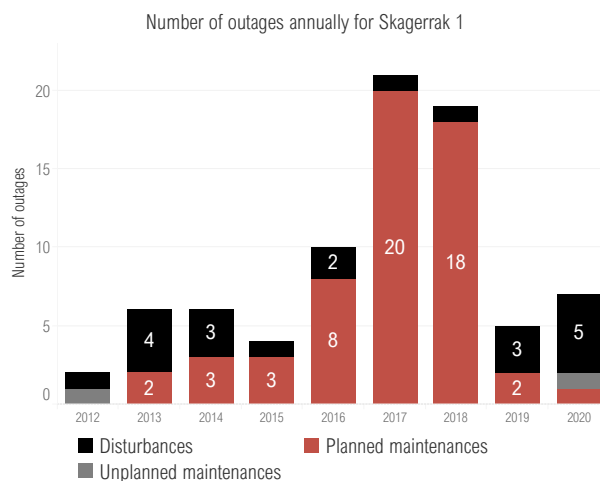

Figure 5.59: The annual number of disturbances, unplanned and planned maintenance outages and other outages for Skagerrak 1 for the years 2012–2020. Skagerrak 1 had no other outages during the years 2012–2020.

5.3.14 Skagerrak 2

Figure 5.60 presents the availability and utilisation of Skagerrak 2 for 2020 and Table 5.17 presents the numerical values behind it. Skagerrak 1 and Skagerrak 2 have been in operation since 1976 and are the oldest HVDC links in operation in the Nordic countries. In Norway, the links are connected to Kristiansand on the southern coast (bidding zone NO2) and in Denmark to Tjele (bidding zone DK1), 15 km east of the town of Viborg in the northern part of Jutland. The transmission capacity of Skagerrak 2 is 236 MW at the receiving end.

In 2020, Skagerrak 2 had an available technical capacity of 56 %. The technical capacity not used was 22 %. Totally, 0.6 TWh (31 % of the technical capacity) was transmitted south from Norway to the Denmark and 0.1 TWh (3 % of the technical capacity) was transmitted north to Norway.

There was no annual maintenance of Skagerrak 2, but one other planned maintenance outage of Skagerrak 1–3 due to reconstruction work in Kristiansand in October. Skagerrak 2 had 1 major and 4 minor disturbance outages and 1 minor unplanned maintenance outage during 2020. The severe disturbance outage lasted 123 days and was caused by a submarine cable fault due to a ship.

Skagerrak 1, 2, 3 and 4 have been limited due to “careful operation” since the Skagerrak 4 cable faults in December 2019. In 2020, the capacity was prioritised followingly:

- 1.1–16.3 North direction prioritised
- 16.3–18.3 Discharge of Skagerrak 4 before switching polarity
- 18.3–31.12 South direction prioritised

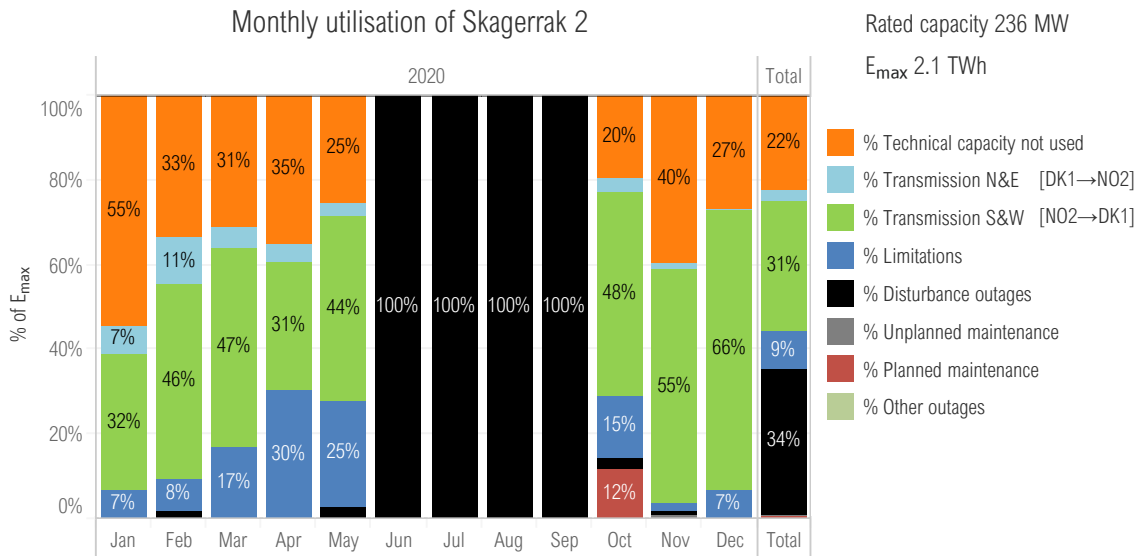

Figure 5.60: Percentage distribution of the availability and utilisation per category according to month for Skagerrak 2 in 2020. The availability and utilisation categories are defined in detail in Chapter 3.

Table 5.17: Monthly distribution of the technical capacity (E_{max}) for Skagerrak 2 in 2020. Note that losses are not included in the technical capacity (E_{max}), as is shown in Figure 3.1.

Monthly utilisation of Skagerrak 2 (South & West direction NO2→DK1)	Jan	Feb	Mar	Apr	May	Jun	Jul	Aug	Sep	Oct	Nov	Dec	Total	% total
Technical capacity not used, GWh	95.8	54.6	55.1	59.9	44.3	-	-	-	-	34.6	67.4	46.7	458.4	22.1%
Transmission N&E, GWh	11.8	18.8	8.2	6.6	6.2	-	-	-	-	5.0	2.8	0.5	59.8	2.9%
Transmission S&W, GWh	56.1	75.1	82.7	51.9	76.6	-	-	-	-	84.9	94.0	116.5	637.7	30.8%
Limitations, GWh	11.9	12.8	29.6	51.6	43.4	-	-	-	-	25.9	3.1	11.8	190.2	9.2%
Disturbance outages, GWh	-	2.9	-	-	5.1	169.9	175.6	175.6	169.9	5.0	1.5	-	705.5	34.0%
Unplanned maintenance, GWh	-	-	-	-	-	-	-	-	-	-	1.2	-	1.2	0.1%
Planned maintenance, GWh	-	-	-	-	-	-	-	-	-	20.3	-	-	20.3	1.0%
Other outages, GWh	-	-	-	-	-	-	-	-	-	-	-	-	-	-
Total, GWh	175.6	164.3	175.6	169.9	175.6	169.9	175.6	175.6	169.9	175.6	169.9	175.6	2073.2	100.0%
Losses SW, GWh	2.8	3.8	3.7	1.9	3.3	-	-	-	-	3.9	4.7	5.8	29.9	1.4%
Losses NE, GWh	0.5	0.9	0.4	0.4	0.3	-	-	-	-	0.3	0.2	0.1	2.9	0.1%

Figure 5.61 presents the annual utilisation of Skagerrak 2 per utilisation and unavailability category for the years 2012–2020.

Figure 5.62 presents the percentage of hours of a year Skagerrak 2 has been affected by either a limitation, a distur-

bance outage, an unplanned or planned maintenance outage or other outage annually during the years 2012–2020. Figure 5.63 presents the annual number of disturbance outages, unplanned and planned maintenance and other outages during the years 2012–2020.

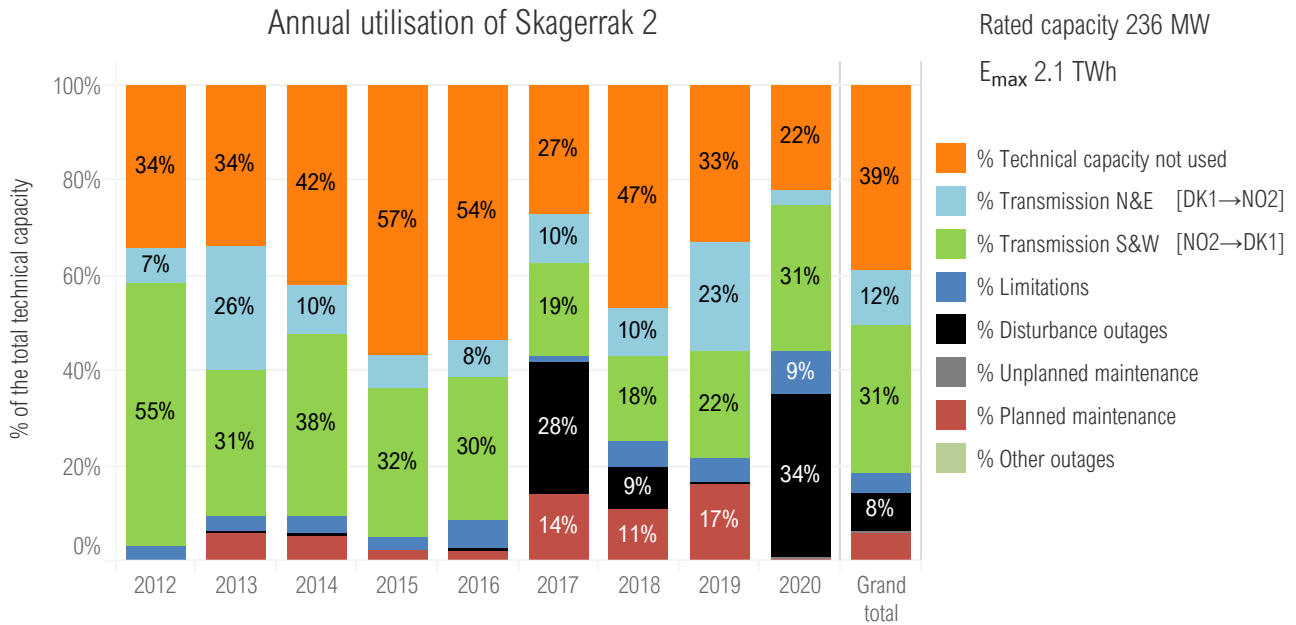

Figure 5.61: Annual utilisation of Skagerrak 2 according to the utilisation and unavailability categories for the years 2012–2020. The utilisation and unavailability categories are described in more detail in Chapter 3.

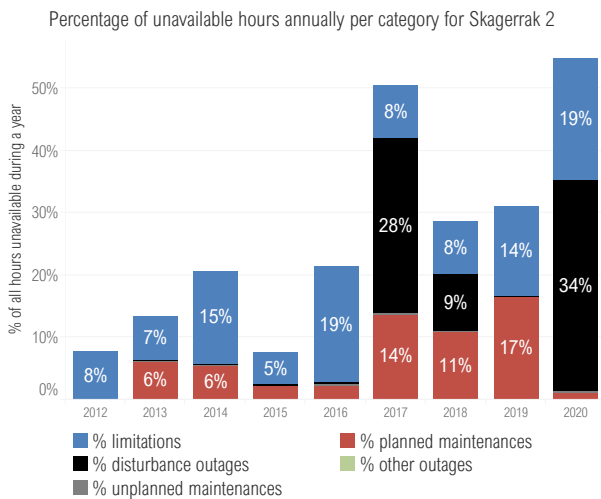

Figure 5.62: Percentage of hours Skagerrak 2 has been affected by either a limitation, unplanned or planned maintenance or a disturbance or other outage annually for the years 2012–2020. The percentage is calculated by counting the number of hours with a limitation or outage and dividing it by the total number of hours in a year. It should be noted, that any single hour can be affected by both an outage and a limitation.

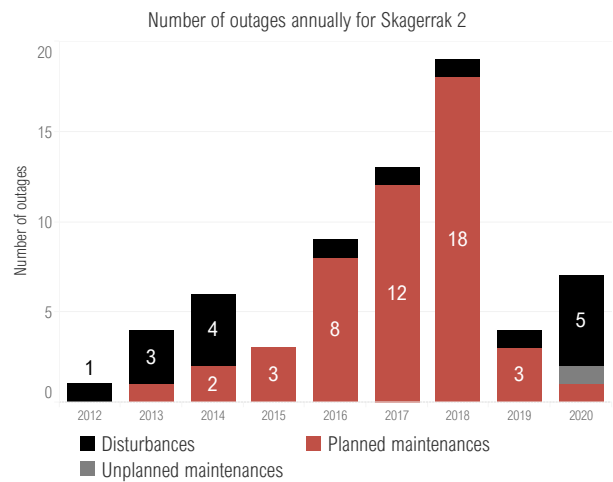

Figure 5.63: The annual number of disturbances, unplanned and planned maintenance outages and other outages for Skagerrak 2 for the years 2012–2020. Skagerrak 2 had no other outages during the years 2012–2020.

5.3.15 Skagerrak 3

Figure 5.64 presents the availability and utilisation of Skagerrak 3 for 2020 and Table 5.18 presents the numerical values behind it. Skagerrak 3 has been in operation since 1993. In Norway, it is connected to Kristiansand (bidding zone NO2) and in Denmark to Tjele (bidding zone DK1). The transmission capacity of Skagerrak 3 is 478 MW at the receiving end.

In 2020, Skagerrak 3 had an available technical capacity of 83 %. The technical capacity not used was 9 %. Totally, 2.9 TWh (68 % of the technical capacity) was transmitted south from Norway to Denmark and 0.3 TWh (6 % of the technical capacity) was transmitted north to Norway.

There was no annual maintenance of Skagerrak 3, but one

other planned maintenance outage of Skagerrak 1–3 due to reconstruction work in Kristiansand in October. Skagerrak 3 had 2 minor disturbance outages during 2020.

Skagerrak 1, 2, 3 and 4 have been limited due to “careful operation” since the Skagerrak 4 cable faults in December 2019. In 2020, the capacity was prioritised followingly:

- 1.1–16.3 North direction prioritised
- 16.3–18.3 Discharge of Skagerrak 4 before switching polarity
- 18.3–31.12 South direction prioritised

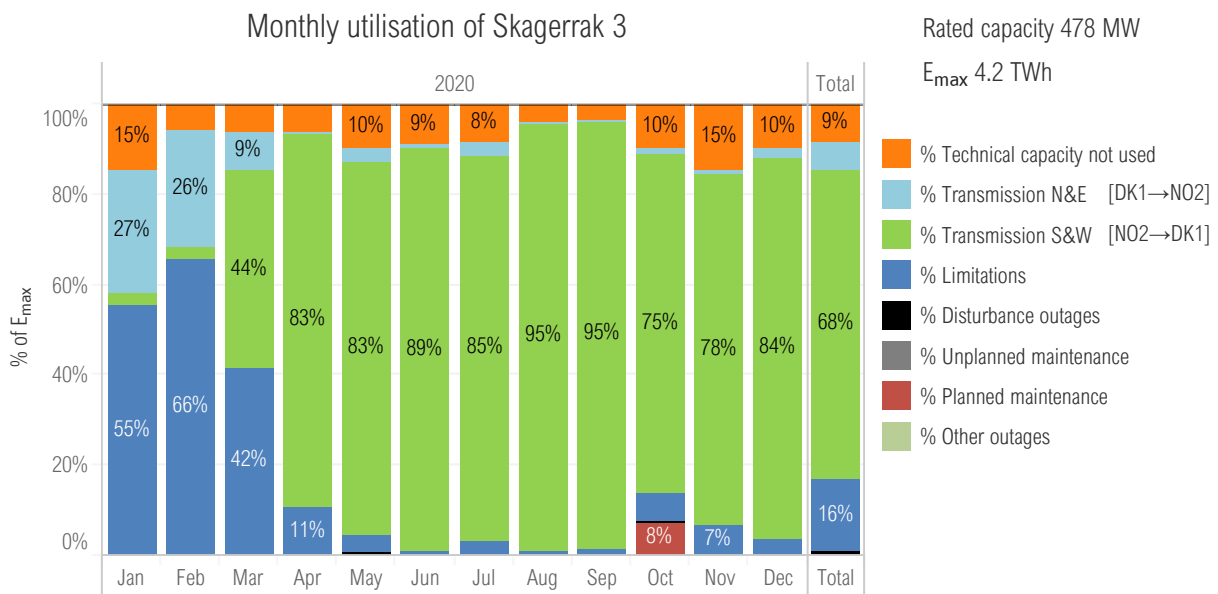

Figure 5.64: Percentage distribution of the availability and utilisation per category according to month for Skagerrak 3 in 2020. The availability and utilisation categories are defined in detail in Chapter 3.

Table 5.18: Monthly distribution of the technical capacity (E_{max}) for Skagerrak 3 in 2020. Note that losses are not included in the technical capacity (E_{max}), as is shown in Figure 3.1.

	Jan	Feb	Mar	Apr	May	Jun	Jul	Aug	Sep	Oct	Nov	Dec	Total	% total
Technical capacity not used, GWh	52.4	19.8	22.4	22.2	34.3	31.2	29.7	14.5	11.7	35.6	51.0	34.5	359.4	8.5%
Transmission N&E, GWh	97.7	85.9	30.6	1.4	11.8	2.9	11.7	-	0.2	4.3	2.8	9.0	258.2	6.1%
Transmission S&W, GWh	9.2	8.8	154.9	284.3	294.6	307.3	304.3	339.1	328.4	267.4	267.4	302.5	2868.2	68.2%
Limitations, GWh	196.6	218.4	147.7	36.2	11.9	3.0	10.9	3.0	4.9	21.3	23.8	12.4	690.1	16.4%
Disturbance outages, GWh	-	-	-	-	3.3	-	-	-	-	-	-	-	3.3	0.1%
Unplanned maintenance, GWh	-	-	-	-	-	-	-	-	-	-	-	-	-	-
Planned maintenance, GWh	-	-	-	-	-	-	-	-	-	27.5	-	-	27.5	0.7%
Other outages, GWh	-	-	-	-	-	-	-	-	-	-	-	-	-	-
Total, GWh	355.9	332.9	355.7	344.2	355.8	344.5	356.5	356.7	345.1	356.1	345.0	358.5	4206.8	100.0%
Losses SW, GWh	0.6	0.7	3.6	6.1	6.6	8.5	7.9	9.0	8.5	6.5	6.7	7.8	72.5	1.7%
Losses NE, GWh	2.5	2.1	0.8	0.1	0.3	0.1	0.3	-	-	0.1	0.1	0.2	6.8	0.2%

Figure 5.65 presents the annual utilisation of Skagerrak 3 per utilisation and unavailability category for the years 2012–2020.

Figure 5.66 presents the percentage of hours of a year Skagerrak 3 has been affected by either a limitation, a distur-

bance outage, an unplanned or planned maintenance outage or other outage annually during the years 2012–2020. Figure 5.67 presents the annual number of disturbance outages, unplanned and planned maintenance and other outages during the years 2012–2020.

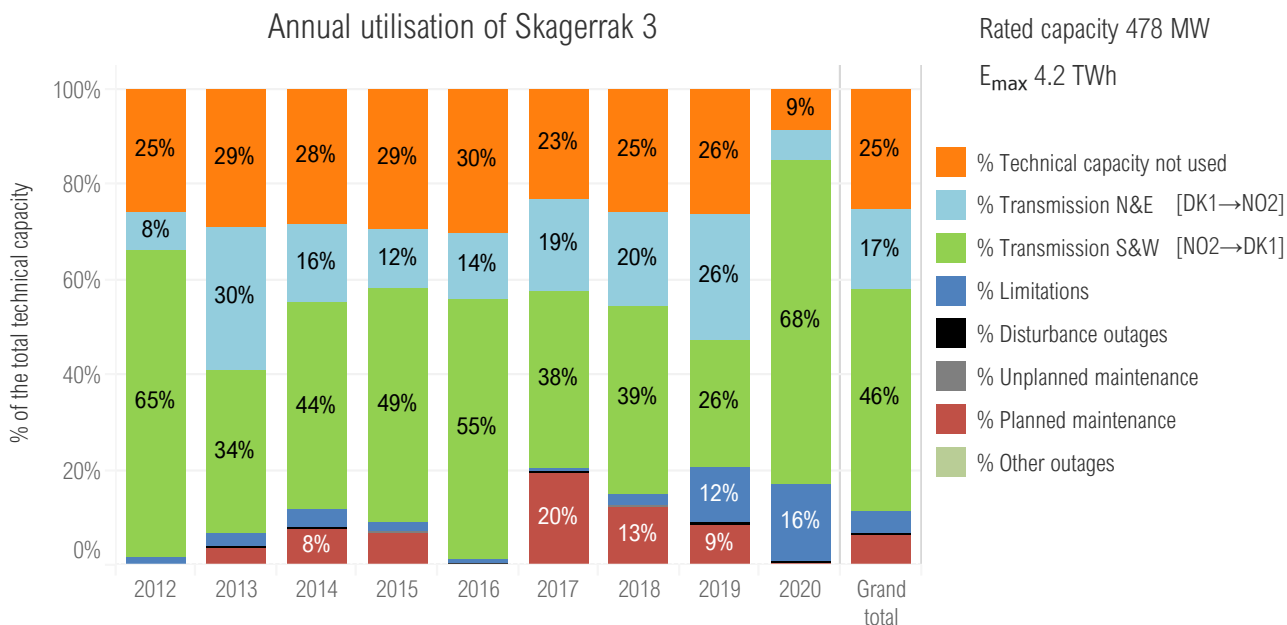

Figure 5.65: Annual utilisation of Skagerrak 3 according to the utilisation and unavailability categories for the years 2012–2020. The utilisation and unavailability categories are described in more detail in Chapter 3.

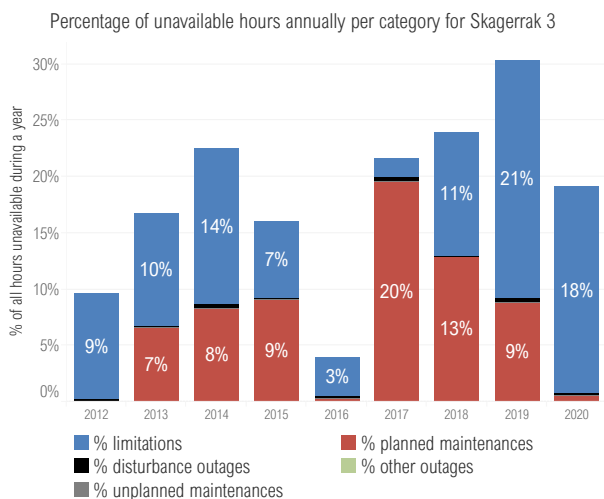

Figure 5.66: Percentage of hours Skagerrak 3 has been affected by either a limitation, unplanned or planned maintenance or a disturbance or other outage annually for the years 2012–2020. The percentage is calculated by counting the number of hours with a limitation or outage and dividing it by the total number of hours in a year. It should be noted, that any single hour can be affected by both an outage and a limitation.

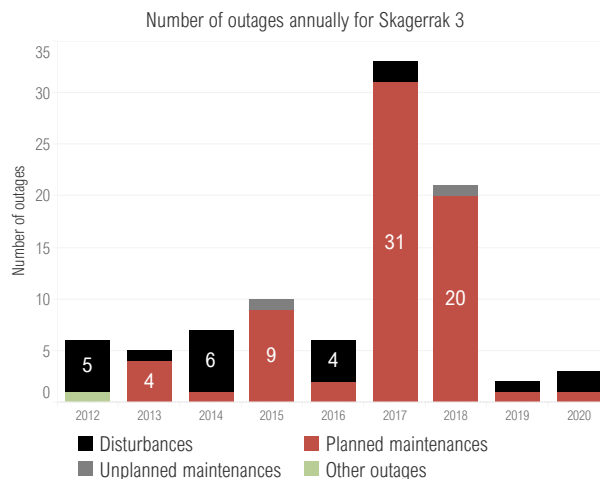

Figure 5.67: The annual number of disturbances, unplanned and planned maintenance outages and other outages for Skagerrak 3 for the years 2012–2020.

5.3.16 Skagerrak 4

Figure 5.68 presents the availability and utilisation of Skagerrak 4 for 2020 and Table 5.19 presents the numerical values behind it. Skagerrak 4 has been in commercial operation since 29 December 2014. In Norway, it is connected to Kristiansand (bidding zone NO2) and in Denmark to Tjele (bidding zone DK1). The transmission capacity is 682 MW at the receiving end.

In 2020, Skagerrak 4 had an available technical capacity of 83 %. The technical capacity not used was 12 %. Totally, 3.8 TWh (64 % of the technical capacity) was transmitted south from Norway to the Denmark and 0.4 TWh (7 % of the technical capacity) was transmitted north to Norway.

The annual maintenance of Skagerrak 4 lasted 4 days in September. Furthermore, there was an additional planned

maintenance outage from May to July to cut cable samples for tests and investigations and one minimal planned maintenance outage in October. Skagerrak 4 had no disturbance outages and 1 minor unplanned maintenance outage during 2020.

Skagerrak 1, 2, 3 and 4 have been limited due to “careful operation” since the Skagerrak 4 cable faults in December 2019. In 2020, the capacity was prioritised followingly:

- 1.1–16.3 North direction prioritised
- 16.3–18.3 Discharge of Skagerrak 4 before switching polarity
- 18.3–31.12 South direction prioritised

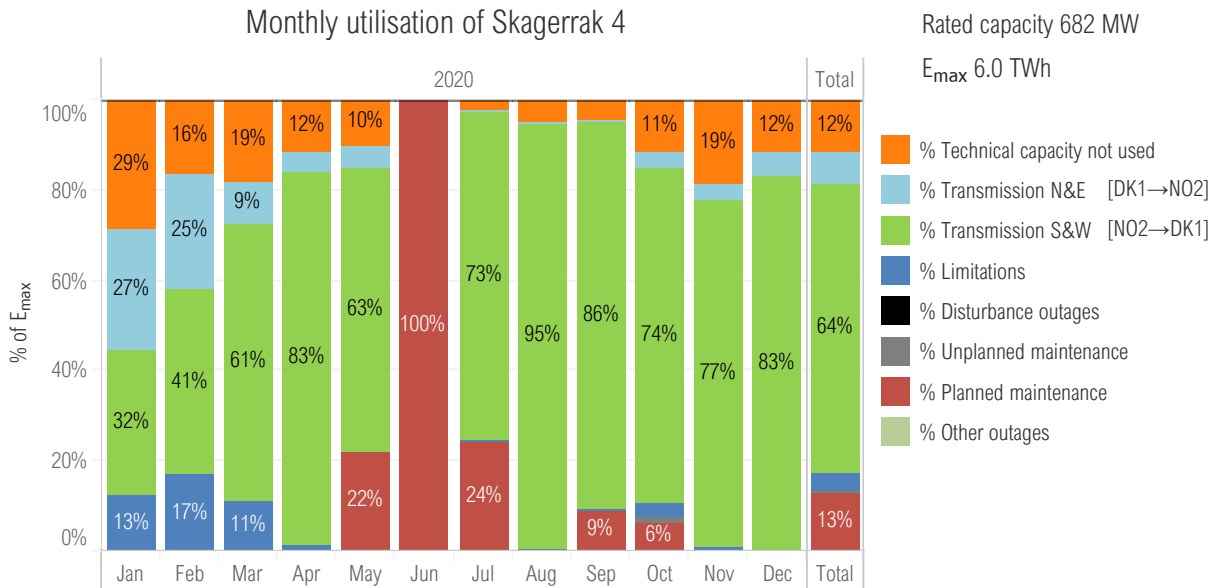

Figure 5.68: Percentage distribution of the availability and utilisation per category according to month for Skagerrak 4 in 2020. The availability and utilisation categories are defined in detail in Chapter 3.

Table 5.19: Monthly distribution of the technical capacity (E_{max}) for Skagerrak 4 in 2020. Note that losses are not included in the technical capacity (E_{max}), as is shown in Figure 3.1.

	Jan	Feb	Mar	Apr	May	Jun	Jul	Aug	Sep	Oct	Nov	Dec	Total	% total
Technical capacity not used, GWh	145.0	78.2	94.0	57.2	53.0	-	12.4	24.6	21.7	58.0	92.3	58.9	695.4	11.6%
Transmission N&E, GWh	136.5	120.0	47.2	21.2	24.2	-	1.6	1.0	2.9	19.5	18.2	27.9	420.4	7.0%
Transmission S&W, GWh	162.4	196.5	310.1	405.9	319.9	-	369.5	480.4	421.0	375.4	376.2	420.6	3838.0	64.1%
Limitations, GWh	63.4	79.9	56.1	7.1	-	-	0.6	2.1	0.6	15.3	4.2	-	229.4	3.8%
Disturbance outages, GWh	-	-	-	-	-	-	-	-	-	-	-	-	-	-
Unplanned maintenance, GWh	-	-	-	-	-	-	-	-	-	6.8	-	-	6.8	0.1%
Planned maintenance, GWh	-	-	-	-	110.3	491.0	123.3	-	45.0	32.5	-	-	802.2	13.4%
Other outages, GWh	-	-	-	-	-	-	-	-	-	-	-	-	-	-
Total, GWh	507.4	474.7	507.4	491.5	507.4	491.0	507.4	508.1	491.3	507.4	491.0	507.4	5992.2	100.0%
Losses SW, GWh	2.5	3.0	6.3	9.2	7.3	-	7.5	9.7	8.9	8.0	7.6	8.5	78.5	1.3%
Losses NE, GWh	3.6	3.3	1.2	0.5	0.6	-	-	-	0.1	0.5	0.5	0.8	11.1	0.2%

Figure 5.69 presents the annual utilisation of Skagerrak 4 per utilisation and unavailability category for the years 2015–2020.

Figure 5.70 presents the percentage of hours of a year Skagerrak 4 has been affected by either a limitation, a distur-

bance outage, an unplanned or planned maintenance outage or other outage annually during the years 2015–2020. Figure 5.71 presents the annual number of disturbance outages, unplanned and planned maintenance and other outages during the years 2015–2020.

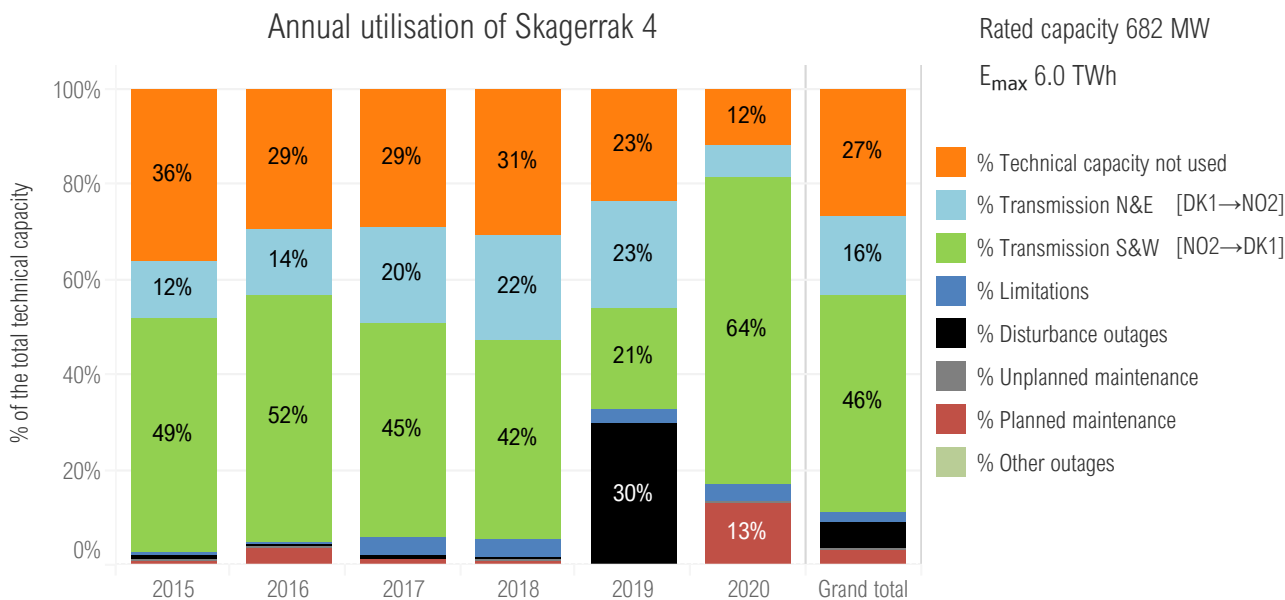

Figure 5.69: Annual utilisation of Skagerrak 4 according to the utilisation and unavailability categories for the years 2015–2020. The utilisation and unavailability categories are described in more detail in Chapter 3.

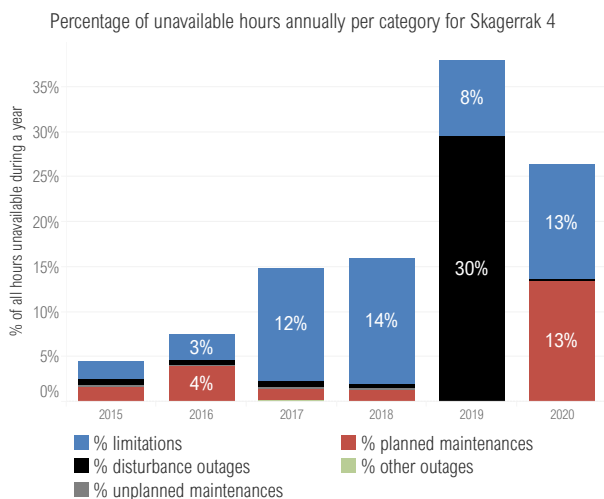

Figure 5.70: Percentage of hours Skagerrak 4 has been affected by either a limitation, unplanned or planned maintenance or a disturbance or other outage annually for the years 2015–2020. The percentage is calculated by counting the number of hours with a limitation or outage and dividing it by the total number of hours in a year. It should be noted, that any single hour can be affected by both an outage and a limitation.

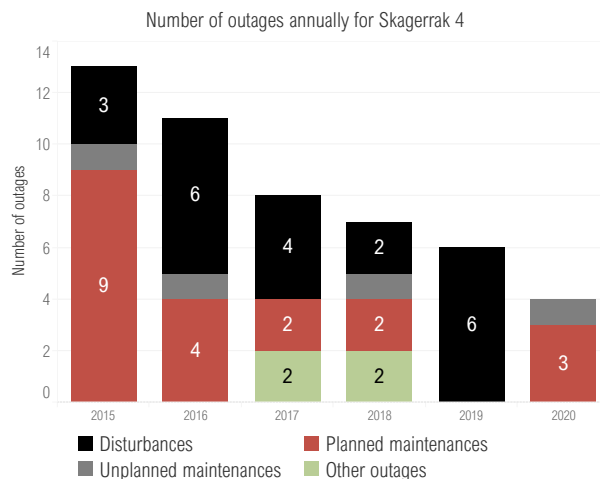

Figure 5.71: The annual number of disturbances, unplanned and planned maintenance outages and other outages for Skagerrak 4 for the years 2015–2020.

5.3.17 Storebaelt

Figure 5.72 presents the availability and utilisation of Storebaelt for 2020 and Table 5.20 presents the numerical values behind it. Storebaelt has been in operation since 2010. It connects the western part of the Danish system, which belongs to the Continental European synchronous system (Jutland and the island of Fynen), with the eastern part, belonging to the Nordic synchronous system (Zealand). The link is connected to Fraugde on Fynen (bidding zone DK1) and to Herslev on Zealand (bidding zone DK2). The transmission capacity is 600 MW.

In 2020, Storebaelt had an available technical capacity of 99.7 %. The technical capacity not used was 29 %. Totally, 3.5 TWh (67 % of the technical capacity) was transmitted east from Jutland to Zealand (DK1→DK2) and 0.2 TWh (4 % of the technical capacity) was transmitted west to Jutland (DK2→DK1).

Storebaelt had no annual maintenance in 2020. Instead, there were 2 other minor maintenance outages for oil filling and valve hall work. Storebaelt had 3 minor disturbance outages in 2020.

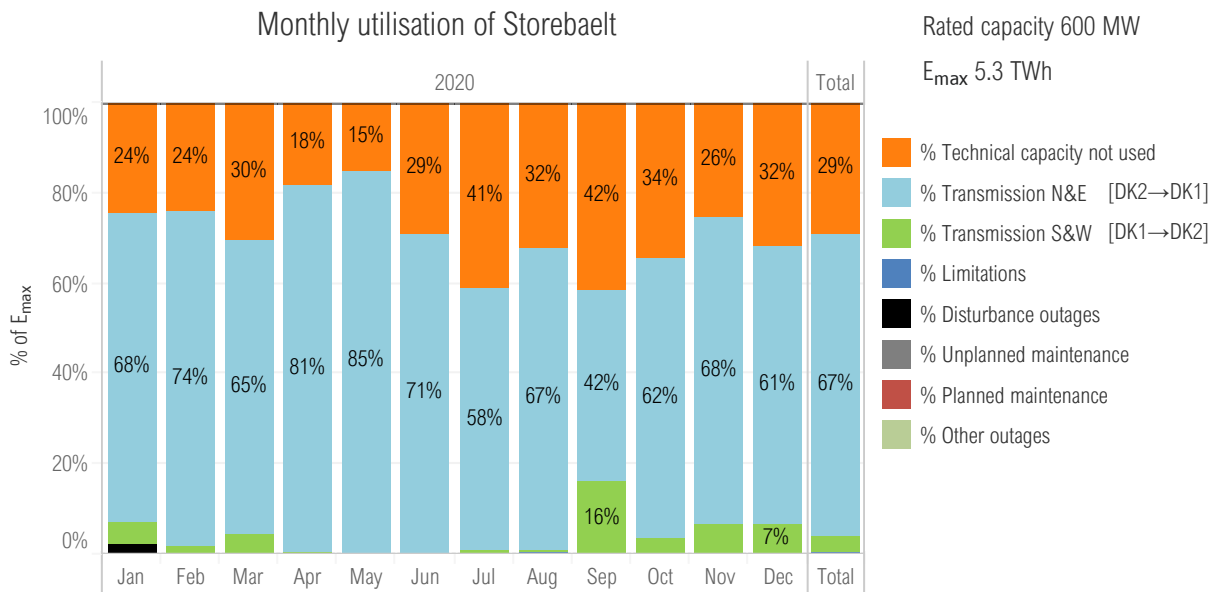

Figure 5.72: Percentage distribution of the availability and utilisation per category according to month for Storebaelt in 2020. The availability and utilisation categories are defined in detail in Chapter 3.

Table 5.20: Monthly distribution of the technical capacity (E_{max}) for Storebaelt in 2020. Note that losses are not included in the technical capacity (E_{max}), as is shown in Figure 3.1.

Monthly utilisation of Storebaelt (South & West direction DK1→DK2)	Jan	Feb	Mar	Apr	May	Jun	Jul	Aug	Sep	Oct	Nov	Dec	Total	% total
	Technical capacity not used, GWh	108.8	100.8	135.3	78.9	68.5	125.5	182.9	144.3	180.1	153.6	110.4	142.3	1531.4
Transmission N&E, GWh	304.9	310.0	291.9	352.0	377.2	305.9	258.9	297.7	182.0	276.4	293.4	274.0	3524.4	66.9%
Transmission S&W, GWh	22.6	6.8	19.1	1.1	0.6	0.6	4.7	2.1	69.4	16.3	27.6	30.0	201.0	3.8%
Limitations, GWh	-	-	-	-	-	-	-	2.1	-	-	0.5	-	2.7	0.1%
Disturbance outages, GWh	10.1	-	-	-	-	-	-	0.2	-	-	-	-	10.3	0.2%
Unplanned maintenance, GWh	-	-	-	-	-	-	-	-	0.5	-	-	-	0.5	0.0%
Planned maintenance, GWh	-	-	-	-	-	-	-	-	-	0.1	-	-	0.1	0.0%
Other outages, GWh	-	-	-	-	-	-	-	-	-	-	-	-	-	-
Total, GWh	446.4	417.6	446.4	432.0	446.4	432.0	446.4	446.4	432.0	446.4	432.0	446.4	5270.4	100.0%
Losses SW, GWh	0.3	0.1	0.3	-	-	-	0.1	0.1	1.1	0.3	0.4	0.5	3.2	0.1%
Losses NE, GWh	5.3	5.4	5.0	6.0	6.6	5.1	4.4	5.1	3.2	4.7	5.1	4.7	60.5	1.1%

Figure 5.73 presents the annual utilisation of Storebaelt per utilisation and unavailability category for the years 2012–2020.

Figure 5.74 presents the percentage of hours of a year Storebaelt has been affected by either a limitation, a disturbance

outage, an unplanned or planned maintenance outage or other outage annually during the years 2012–2020. Figure 5.75 presents the annual number of disturbance outages, unplanned and planned maintenance and other outages during the years 2012–2020.

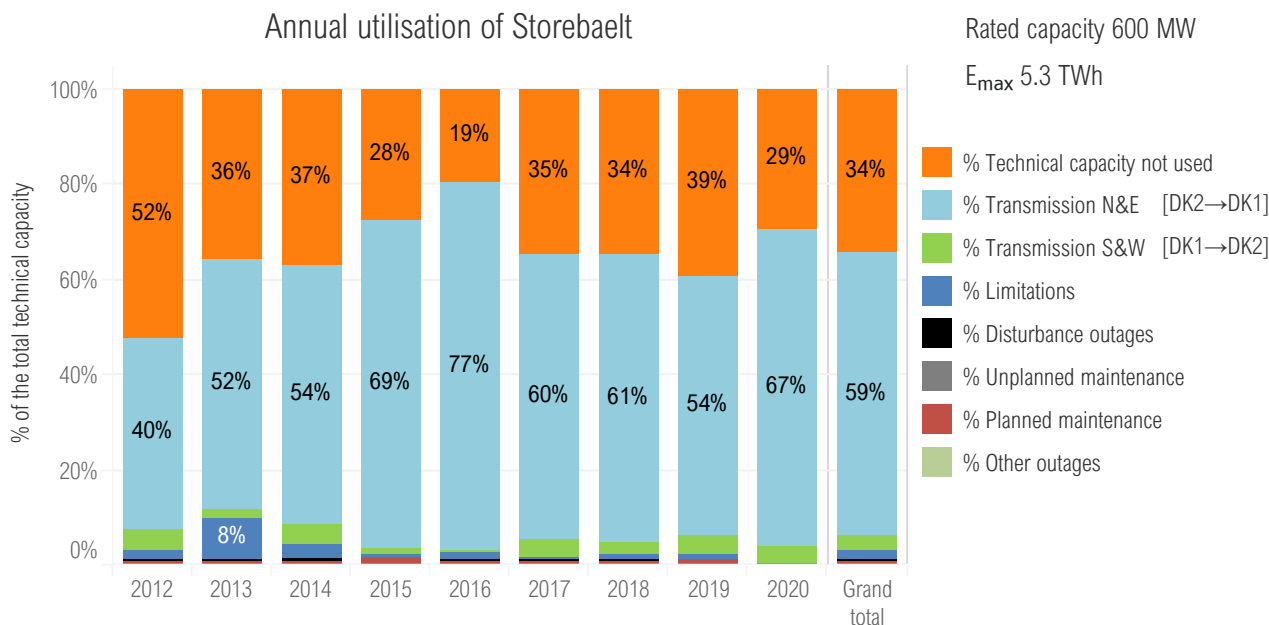

Figure 5.73: Annual utilisation of Storebaelt according to the utilisation and unavailability categories for the years 2012–2020. The utilisation and unavailability categories are described in more detail in Chapter 3.

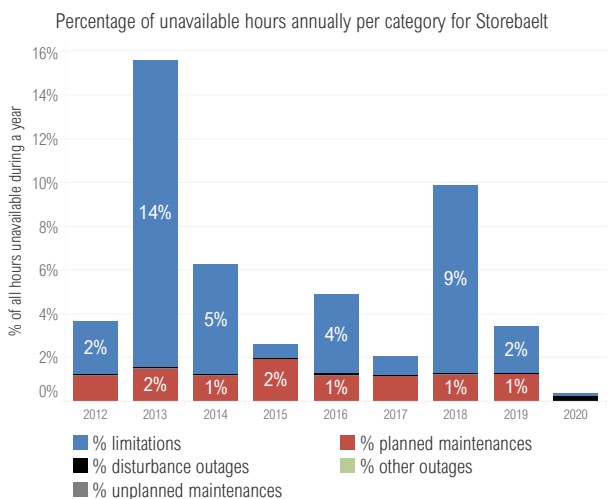

Figure 5.74: Percentage of hours Storebaelt has been affected by either a limitation, unplanned or planned maintenance or a disturbance or other outage annually for the years 2012–2020. The percentage is calculated by counting the number of hours with a limitation or outage and dividing it by the total number of hours in a year. It should be noted, that any single hour can be affected by both an outage and a limitation.

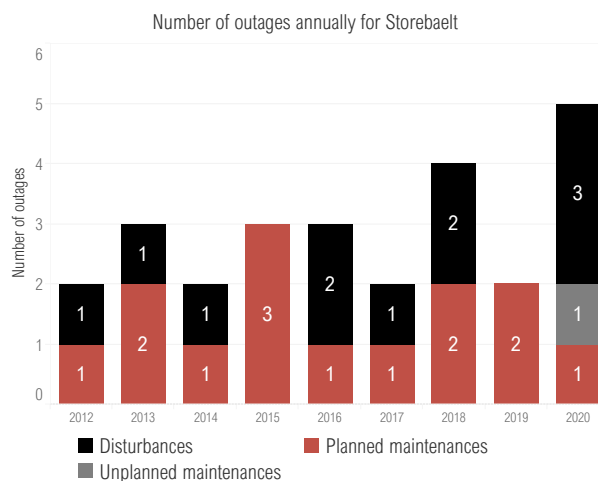

Figure 5.75: The annual number of disturbances, unplanned and planned maintenance outages and other outages for Storebaelt for the years 2012–2020. Storebaelt had no other outages during the years 2012–2020.

5.3.18 SwePol

Figure 5.76 presents the availability and utilisation of SwePol for 2020 and Table 5.21 presents the numerical values behind it. SwePol Link has been in operation since 2000 and it connects the Swedish and Polish transmission grids. In south-eastern Sweden (bidding zone SE4) it is connected to Stårnö and in Poland (bidding zone PL) to Slupsk. The transmission capacity is 600 MW.

In 2020, SwePol had an available technical capacity of 87 %. The technical capacity not used was 13 %. Totally, 3.8 TWh (72 % of the technical capacity) was transmitted south from

Sweden to Poland and >0.1 TWh (0.2 % of the technical capacity) was transmitted north to Sweden.

The annual maintenance of SwePol lasted 6 days in September. Additionally, SwePol had 3 other planned maintenance outages and 1 other outage during 2020. SwePol had 3 minor disturbance outages and 1 more severe disturbance outage in 2020. The severe disturbance outage was caused by a fire in the AC filter on the Polish side in January, and it took 19 days to bring the HVDC link back online after it.

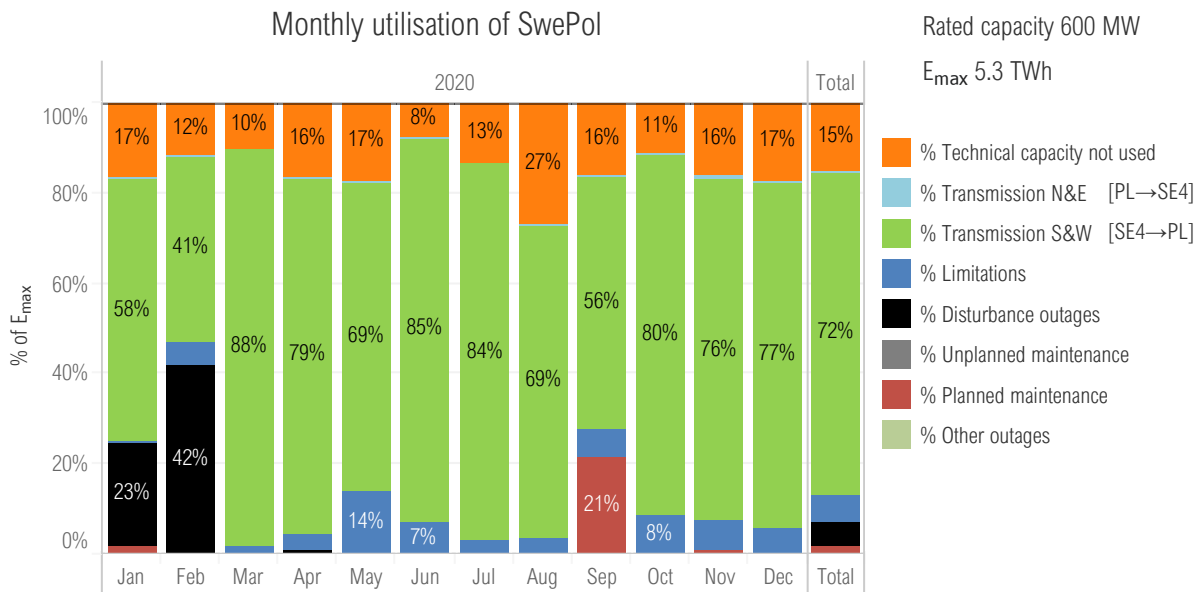

Figure 5.76: Percentage distribution of the availability and utilisation per category according to month for SwePol in 2020. The availability and utilisation categories are defined in detail in Chapter 3.

Table 5.21: Monthly distribution of the technical capacity (E_{max}) for SwePol in 2020. Note that losses are not included in the technical capacity (E_{max}), as is shown in Figure 3.1.

Monthly utilisation of SwePol (South & West direction SE4→PL)															
	Jan	Feb	Mar	Apr	May	Jun	Jul	Aug	Sep	Oct	Nov	Dec	Total	% total	
Technical capacity not used, GWh	74.3	48.6	46.4	70.7	77.7	32.5	59.5	119.2	68.7	50.2	69.6	77.7	795.1	15.1%	
Transmission N&E, GWh	1.8	0.7	-	0.9	0.7	0.6	-	3.3	0.5	1.2	2.7	0.2	12.6	0.2%	
Transmission S&W, GWh	258.8	171.8	392.1	340.4	306.9	367.1	373.8	308.7	242.8	357.4	327.1	341.9	3788.9	71.9%	
Limitations, GWh	2.4	21.9	7.9	16.9	61.1	31.8	13.1	14.8	27.6	37.7	27.8	26.2	289.1	5.5%	
Disturbance outages, GWh	101.3	174.6	-	3.0	-	-	-	-	-	-	-	0.5	279.4	5.3%	
Unplanned maintenance, GWh	-	-	-	-	-	-	-	-	-	-	-	-	-	-	
Planned maintenance, GWh	7.8	-	-	-	-	-	-	-	92.4	-	4.7	-	104.9	2.0%	
Other outages, GWh	-	-	-	-	-	-	-	0.4	-	-	-	-	0.4	0.0%	
Total, GWh	446.4	417.6	446.4	432.0	446.4	432.0	446.4	446.4	432.0	446.4	432.0	446.4	5270.4	100.0%	
Losses SW, GWh	7.5	4.8	11.2	9.5	8.2	10.5	10.7	8.6	6.5	10.3	9.3	9.7	106.8	2.0%	
Losses NE, GWh	-	-	-	-	-	-	-	0.1	-	-	0.1	-	0.3	0.0%	

Figure 5.77 presents the annual utilisation of SwePol per utilisation and unavailability category for the years 2012–2020.

Figure 5.78 presents the percentage of hours of a year SwePol has been affected by either a limitation, a disturbance out-

age, an unplanned or planned maintenance outage or other outage annually during the years 2012–2020. Figure 5.79 presents the annual number of disturbance outages, unplanned and planned maintenance and other outages during the years 2012–2020.

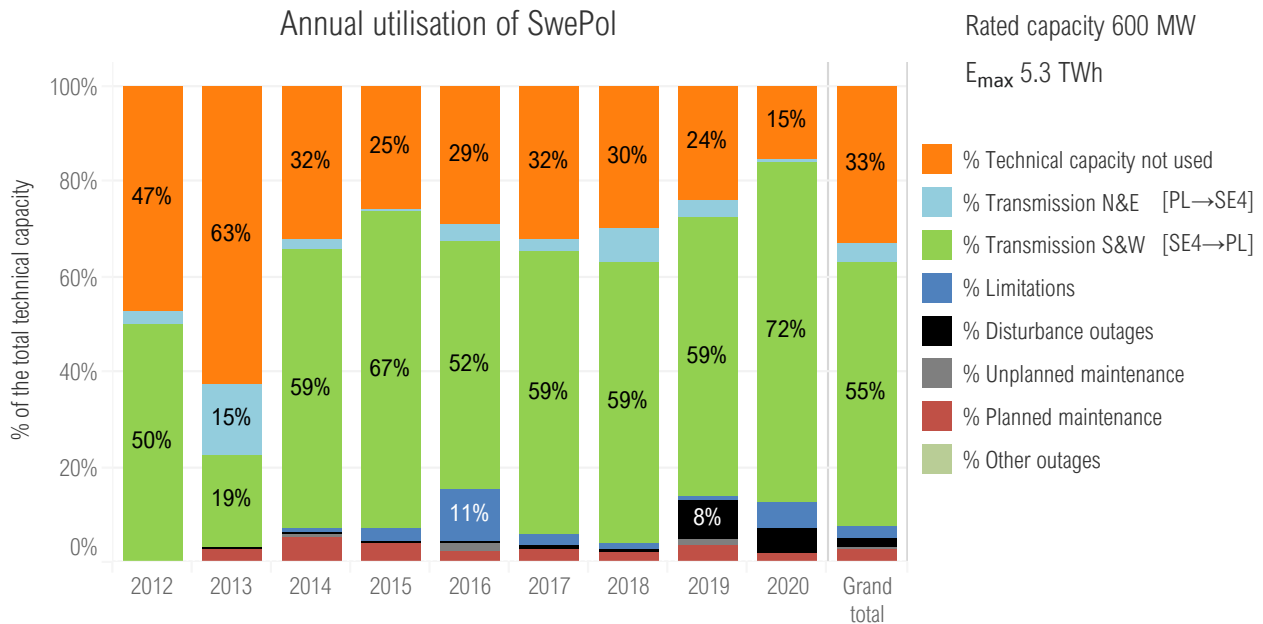

Figure 5.77: Annual utilisation of SwePol according to the utilisation and unavailability categories for the years 2012–2020. The utilisation and unavailability categories are described in more detail in Chapter 3.

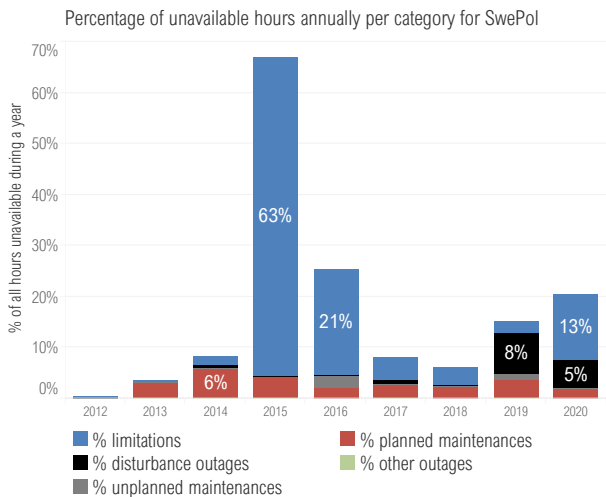

Figure 5.78: Percentage of hours SwePol has been affected by either a limitation, unplanned or planned maintenance or a disturbance or other outage annually for the years 2012–2020. The percentage is calculated by counting the number of hours with a limitation or outage and dividing it by the total number of hours in a year. It should be noted, that any single hour can be affected by both an outage and a limitation.

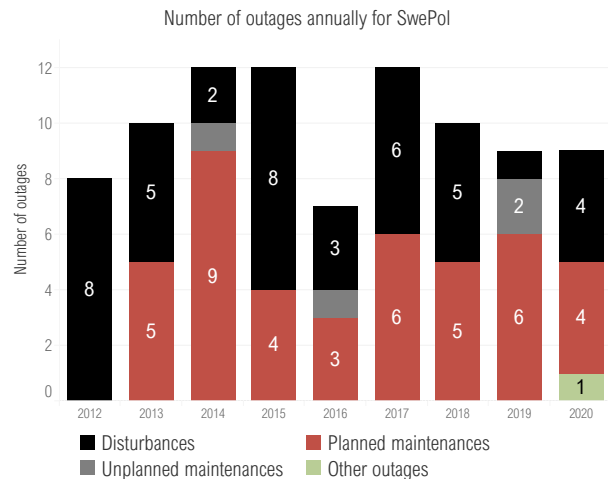

Figure 5.79: The annual number of disturbances, unplanned and planned maintenance outages and other outages for SwePol for the years 2012–2020. SwePol had no other outages during the years 2012–2020.

5.3.19 Vyborg Link

Figure 5.80 and Figure 5.81 present the monthly availability and utilisation of the Vyborg Link separately for each direction for 2020. Table 5.22 and Table 5.23 present the numerical values behind the monthly figures.

The Vyborg Link is a back-to-back HVDC connection between Russia and Finland. The HVDC substation is situated in Vyborg, Russia, and the 400 kV lines from Vyborg are connected to substations Yllikkälä and Kymi in southern Finland.

Vyborg link has been commissioned four times – first in year 1981, and further in 1982, 1984, and 2000 – with each commissioning increasing the rated capacity by 350 MW. Today, the total technical capacity is 4×350 MW and the commercial transmission capacity is 1.3 GW (with 100 MW allocated for reserves). The transmission direction before 2014 was only towards Finland, but in September 2014 one 350 MW unit was successfully tested to also transmit in the other direction. Therefore, the commercial trade from Finland to Russia was started on 1 December 2014 with the rated capacity of 320 MW (with 30 MW allocated for reserves).

In 2020, the Vyborg Link had an available technical capacity of 90 % in the direction RU→FI. The technical capacity not used was 67 %. Totally, 2.6 TWh (23 % of the technical capacity) was transmitted west from Russia to Finland.

The available technical capacity was 83 % in the direction FI→RU. The technical capacity not used was 82 %. Less than 0.1 TWh (0.7 % of the technical capacity) was transmitted east from Finland to Russia.

There were 3 annual maintenances of Vyborg Link, totally lasting 31 days in July and 44 days during August–September. Additionally, there were 4 other planned maintenance outages and 1 unplanned maintenance during 2020 mainly for corrective purposes. Normally, maintenance work on Vyborg Link causes only limitations because the 350 MW units are not worked on simultaneously. Furthermore, Vyborg Link had 6 disturbance outages during 2020. All but 2 disturbances were shorter than one day. The first longer disturbance lasted 6 days in June and the second lasted 3 days in August.

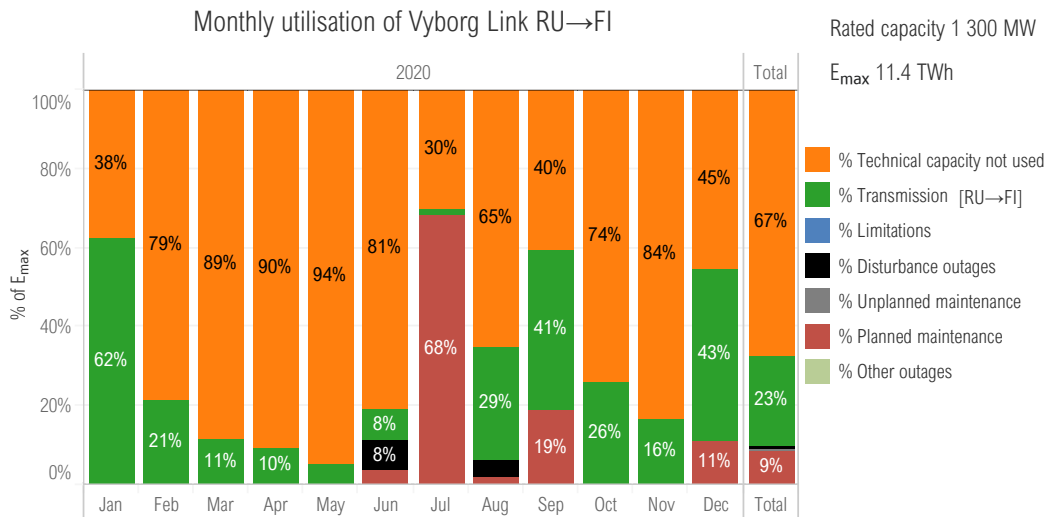

Figure 5.80: Percentage distribution of the availability and utilisation per category according to month for Vyborg Link in direction RU→FI in 2020. The availability and utilisation categories are defined in detail in Chapter 3.

Table 5.22: Monthly distribution of the technical capacity (E_{max}) in direction RU→FI for Vyborg Link in 2020. Transmission losses have been omitted from the table because they can not be calculated due to missing measurements from the Russian side.

	Jan	Feb	Mar	Apr	May	Jun	Jul	Aug	Sep	Oct	Nov	Dec	Total	% total
Technical capacity not used, GWh	364.8	710.9	856.2	846.7	913.5	754.2	292.4	629.5	378.5	717.9	782.5	439.5	7686.6	67.3%
Transmission, GWh	602.4	193.9	111.0	89.3	53.7	76.2	13.6	277.8	381.6	249.3	153.3	418.0	2620.1	22.9%
Limitations, GWh	-	-	-	-	-	-	-	-	-	-	-	-	-	-
Disturbance outages, GWh	-	-	-	-	-	74.0	-	42.8	-	-	-	-	116.8	1.0%
Unplanned maintenance, GWh	-	-	-	-	-	-	-	-	-	-	0.2	-	0.2	0.0%
Planned maintenance, GWh	-	-	-	-	-	31.6	661.3	17.1	175.9	-	-	109.7	995.6	8.7%
Other outages, GWh	-	-	-	-	-	-	-	-	-	-	-	-	-	-
Total, GWh	967.2	904.8	967.2	936.0	967.2	936.0	967.2	967.2	936.0	967.2	936.0	967.2	11419.2	100.0%

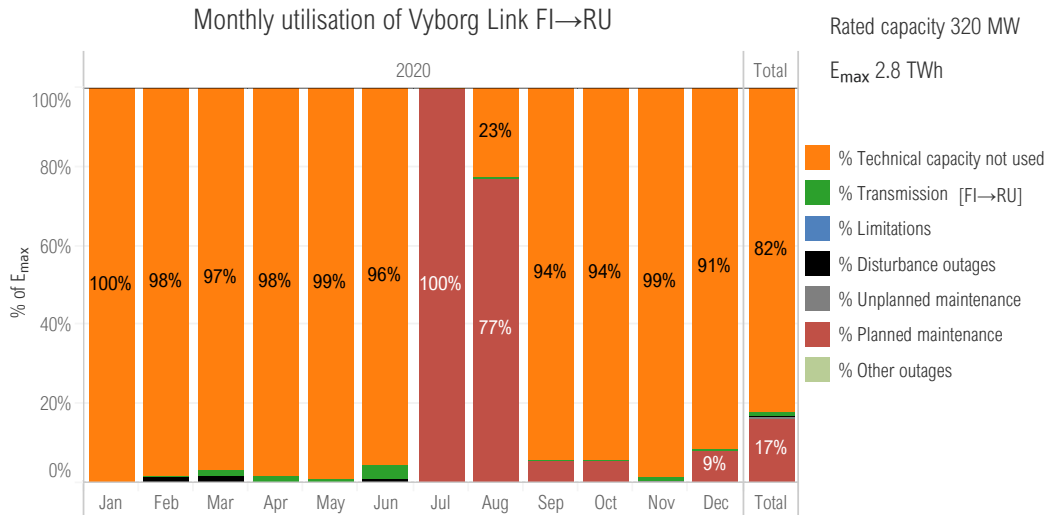

Figure 5.81: Percentage distribution of the availability and utilisation per category according to month for Vyborg Link in direction FI→RU in 2020. The availability and utilisation categories are defined in detail in Chapter 3.

Table 5.23: Monthly distribution of the technical capacity (E_{max}) in direction FI→RU for Vyborg Link in 2020. Transmission losses have been omitted from the table because they can not be calculated due to missing measurements from the Russian side.

Monthly utilisation of Vyborg Link FI→RU		Jan	Feb	Mar	Apr	May	Jun	Jul	Aug	Sep	Oct	Nov	Dec	Total	% total
Technical capacity not used, GWh		238.1	218.9	231.0	226.2	236.3	220.4	0.3	53.8	217.3	224.3	227.4	217.8	2311.8	82.2%
Transmission, GWh		-	1.3	2.3	4.2	1.8	7.8	-	-	-	-	2.1	-	19.5	0.7%
Limitations, GWh		-	-	-	-	-	-	-	-	-	-	-	-	-	-
Disturbance outages, GWh		-	2.5	4.7	-	-	1.9	-	-	-	-	-	-	9.1	0.3%
Unplanned maintenance., GWh		-	-	-	-	-	-	-	-	-	-	1.0	-	1.0	0.0%
Planned maintenance, GWh		-	-	-	-	-	0.3	237.8	184.3	13.1	13.7	-	20.3	469.5	16.7%
Other outages, GWh		-	-	-	-	-	-	-	-	-	-	-	-	-	-
Total, GWh		238.1	222.7	238.1	230.4	238.1	230.4	238.1	238.1	230.4	238.1	230.4	238.1	2810.9	100.0%

Figure 5.82 presents the annual utilisation of Vyborg Link per utilisation and unavailability category for the years 2012–2020.

Figure 5.83 presents the percentage of hours of a year Vyborg Link has been affected by either a limitation, a distur-

bance outage, an unplanned or planned maintenance outage or other outage annually during the years 2012–2020. Figure 5.84 presents the annual number of disturbance outages, unplanned and planned maintenance and other outages during the years 2012–2020.

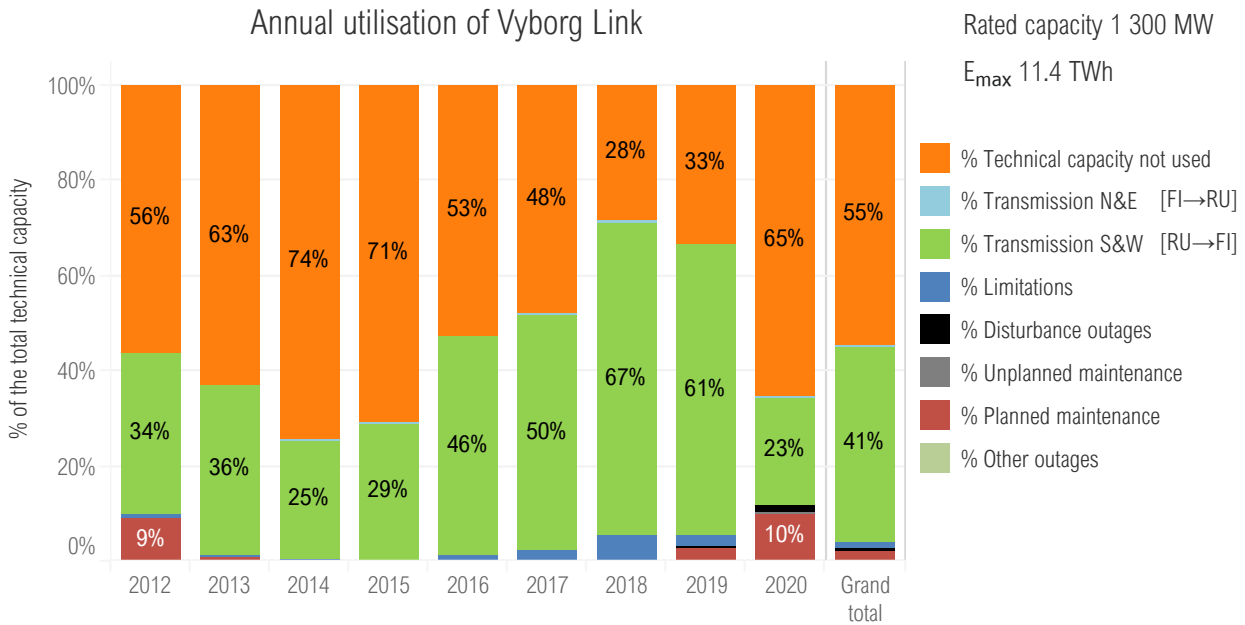

Figure 5.82: Annual utilisation of Vyborg Link according to the utilisation and unavailability categories for the years 2012–2020. The utilisation and unavailability categories are described in more detail in Chapter 3.

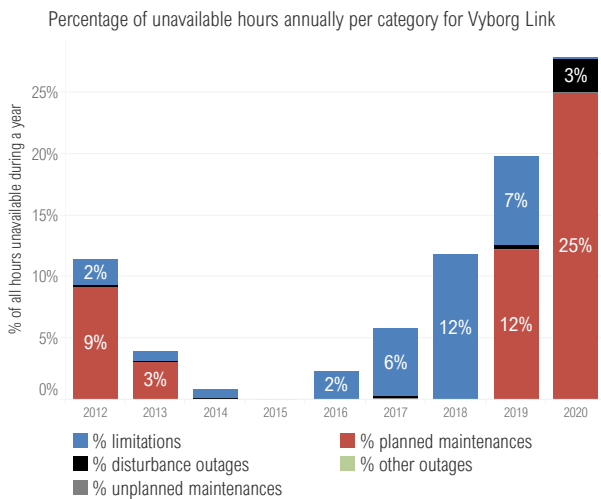

Figure 5.83: Percentage of hours Vyborg Link has been affected by either a limitation, unplanned or planned maintenance or a disturbance or other outage annually for the years 2012–2020. The percentage is calculated by counting the number of hours with a limitation or outage and dividing it by the total number of hours in a year. It should be noted, that any single hour can be affected by both an outage and a limitation.

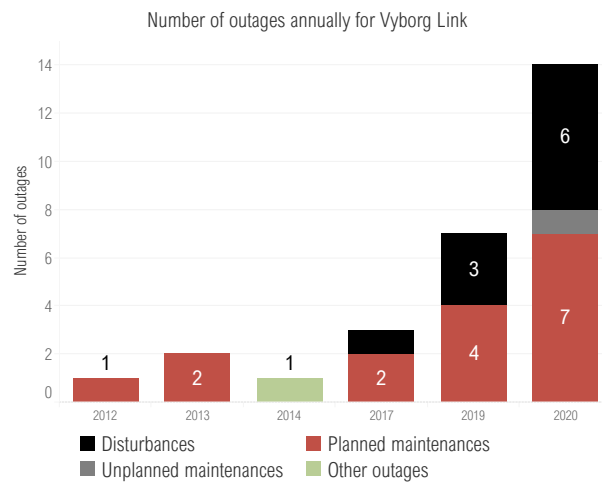

Figure 5.84: The annual number of disturbances, unplanned and planned maintenance outages and other outages for Vyborg Link for the years 2012–2020.

References

- [1] DISTAC, “Nordic Grid Disturbance Statistics 2010.” <https://www.fingrid.fi/contentassets/03690e21eae3449f8fe5d8d96b746e12/pohjoismainen-vika-ja-hairiotilasto-2010-2.pdf>, August 2010.

Appendices

A Schematic presentation of HVDC links

Figure A.1 and Figure A.2 show the schematic presentations of a HVDC converter station having line-commutated converters (LCC) and voltage-source converters (VSC), respectively. All the figures also show definitions for the origin of an event. The origin of each event is used for categorizing a disturbance or a limitation for statistical purposes. The figures

also show the locations of the circuit breakers and measurement points for transferred energy on a link.

It should be noted that these figures are only show an example of a possible LCC or VSC converter station as there are multiple different ways to construct one.

Schematic of a line-commutated converter HVDC station

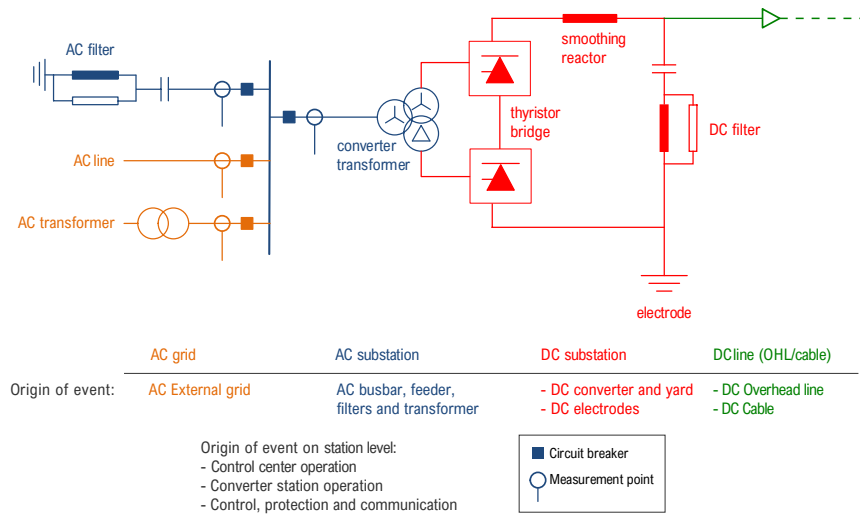

Figure A.1: An example of a line-commutated converter (LCC) station schematic with the connection to the AC grid. The other (remote) side of the HVDC link has a similar albeit mirrored version of the converter station.

Schematic of a voltage-source converter HVDC station

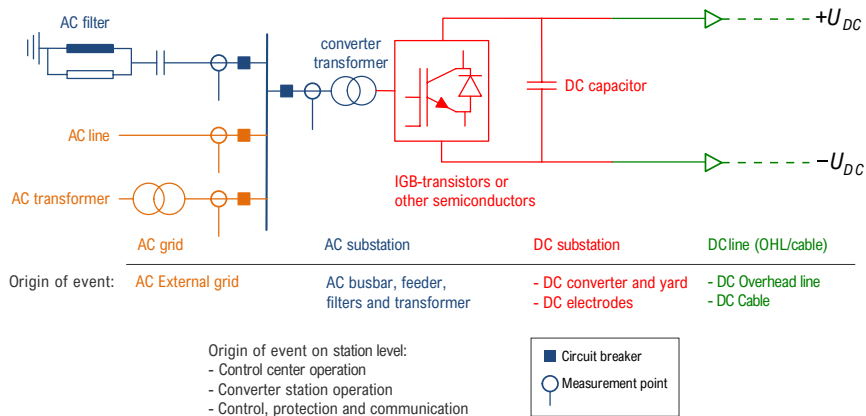

Figure A.2: An example of a voltage-source converter (VSC) station schematic with the connection to the AC grid. The other (remote) side of the HVDC link has a similar albeit mirrored version of the converter station.

B DISTAC origin of event classification

For most outages it is relevant to know the origin of events. Table B.1 show both DISTAC origins and their subcategories, which are now compatible with CIGRE outage codes, as far as possible (it should be noted that compatibility is not

achieved in control and protection areas). The schematics in Appendix A can be helpful in visualizing the different categories.

Table B.1: The origin of event categories and subcategories used in this report.

DISTAC Origin of event	DISTAC / CIGRE Subcategory / Outage Code	Comment
Multiple places	-	Used primarily for annual maintenance in DISTAC.
Control centre operation ¹	C-PL – Local HVDC Control & Protection ¹	Control, protection or monitoring equipment of the local HVDC station, for example, converter firing control, current and voltage regulators, converter and dc yard protections, valve control and protection, and local control sequences.
	C-P.M – Master HVDC Control & Protection ¹	Equipment used for inter-station coordination of current and voltage orders, inter-station sequences, auxiliary controls such as damping controls or higher level controls such as run-back/run-up power control or frequency control.
	C-PT – Control & Protection and Telecommunication ¹	Equipment for coding of control and indication information to be sent over a telecommunication circuit including the telecommunication circuit itself (microwave, PLC or optical).
Converter station operation ¹	Same as for “Control centre operation” above	
Control, protection and communication ¹	Same as for “Control centre operation” above	
AC External grid AC and auxiliary equipment	EXT – External AC System	
	AC-E.F – AC Filter and Shunt Bank	Including AC filter CTs, arresters as well as PLC/RI, SVC, STAT-COM, series capacitor at HVDC station.
	AC-E.SW – Other AC Switchyard Equipment	For example, switches, surge arresters, busbars, insulators.
	AC-E.CP – AC Control and Protection	AC C&P including CTs, VTs, also for auxiliary power and valve cooling.
	AC-E.TX – Converter Transformer	Including interface transformers.
DC converter and yard	AC-E.SC – Synchronous Compensator	Including SC cooling system and exciter.
	AC-E.AX – Auxiliary Equipment and Auxiliary Power	For example, auxiliary transformers, pumps, battery chargers, heat exchangers, cooling system instrumentation, LV switchgear, motor control centres, fire protection, civil works.
	V.E – Valve Electrical	
	V.VC – Valve Cooling	
	V.C – Valve Capacitor	Valve Cooling pipes and parts in valve hall.
DC Electrodes	DC-E.F – DC Filters	
	DC-E.SR – DC Smoothing Reactor	
	DC-E.SW – DC Switching Equipment	
	DC-E.ME – DC Measuring Equipment	
	DC-E.O – Other DC Yard and Valve Hall Equipment	
DC Overhead line	DC-E.GE – DC Ground Electrode	
	DC-E.EL – DC Ground Electrode Line	
DC Cable	TL-OH – DC Overhead Transmission Line	
Other or unknown	TL-C – DC Underground / submarine Cable	
	O – Other	

¹ There is no direct one-to-one compatibility between DISTAC and CIGRE for these definitions.

C Contact persons

Denmark	<p>Energinet Tonne Kjærsvvej 65 DK-7000 Fredericia, Denmark</p> <p>Anders Bratløv Tel. +45 51 38 01 31 E-mail: anv@energinet.dk</p> <p>Morten Vadstrup Tel. +45 25 32 27 74 E-mail: mvd@energinet.dk</p>	Norway	<p>Statnett SF Nydalen allé 33, PB 4904 Nydalen NO-0423 Oslo</p> <p>Jørn Schaug-Pettersen Tel. +47 23 90 35 55 E-mail: jsp@statnett.no</p>
Estonia	<p>Elering AS Kadaka tee 42 Tallinn, Estonia</p> <p>Irene Puusaar Tel. +372 508 4372 E-mail: irene.puusaar@elering.ee</p> <p>Kaur Krusell Tel. +372 564 86011 E-mail: kaur.krusell@elering.ee</p>	Sweden	<p>Svenska kraftnät Sturegatan 1, P.O. Box 1200 SE-172 24 Sundbyberg</p> <p>Jeremy Iehl Tel: +46 10 475 87 78 Mobile: +46 70 512 28 18 E-mail: Jeremy.Iehl@svk.se</p>
Finland	<p>Fingrid Oyj Läkkisepäntie 21, P.O. Box 530 FI-00101 Helsinki, Finland</p> <p>Markku Piironen Tel. +358 30 395 4172 Mobile +358 40 351 1718 E-mail: markku.piironen@fingrid.fi</p>	Production and layout	<p>Hillner Consulting Henrik Hillner Tel. +358 41 505 7004 E-mail: henrik.hillner@hillner.fi</p>
Lithuania	<p>Litgrid AB Viršuliškių skg. 99B LT-05131, Vilnius</p> <p>Valdas Tarvydas Tel. +370 7070 2207 E-mail: valdas.tarvydas@litgrid.eu</p>	Publisher	<p>ENTSO-E AISBL Rue de Spa 8 1000 Brussels, Belgium Tel. +32 2 741 09 50 info@entsoe.eu www.entsoe.eu</p>

D Sorted overview of utilisation and unavailability for all HVDC links

This chapter contains sorted versions of Figure 5.1 Availability and utilisation overview of each HVDC link in 2020.

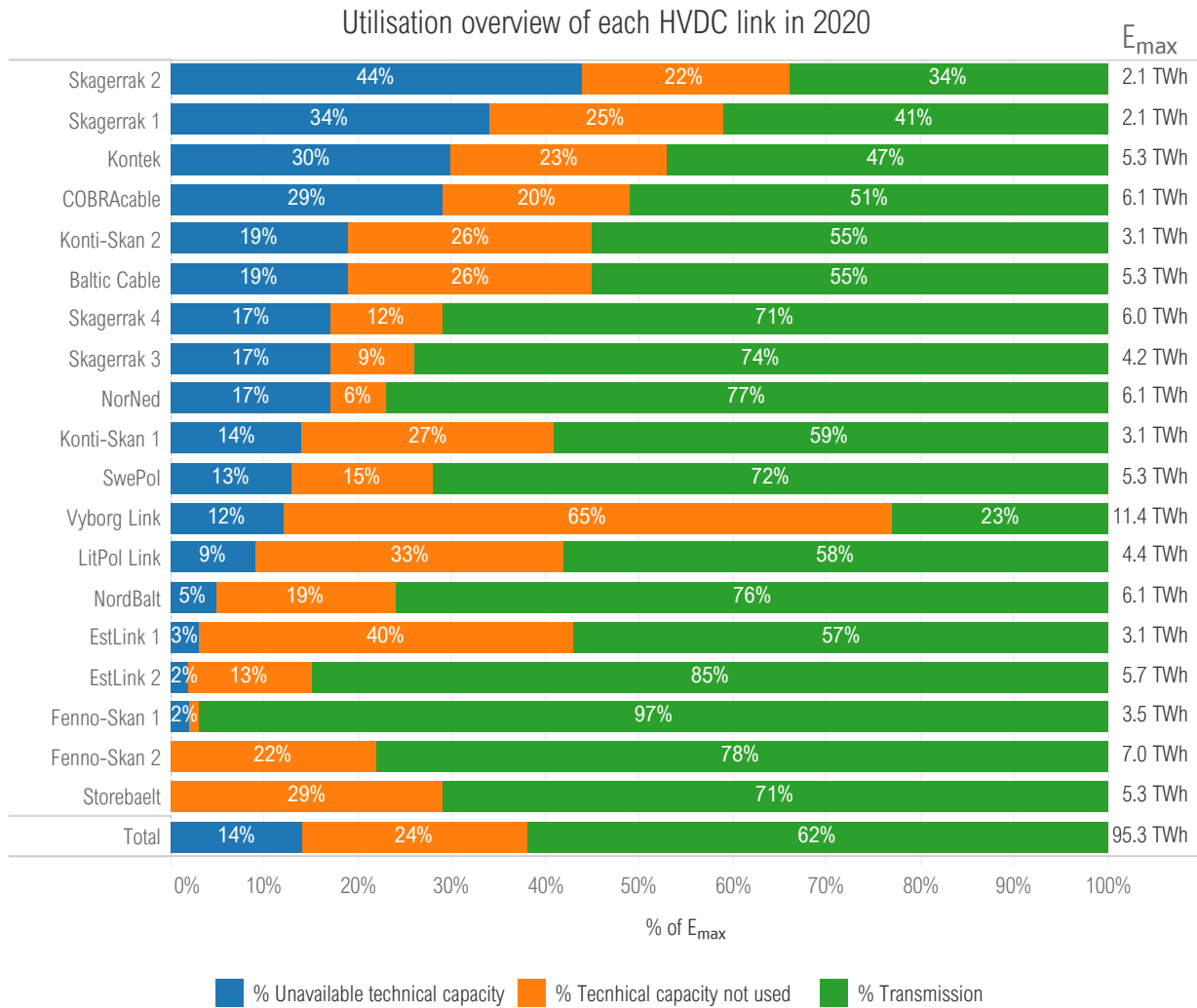

Figure D.1: Overview of each HVDC link sorted by descending unavailable technical capacity (E_U) in 2020.

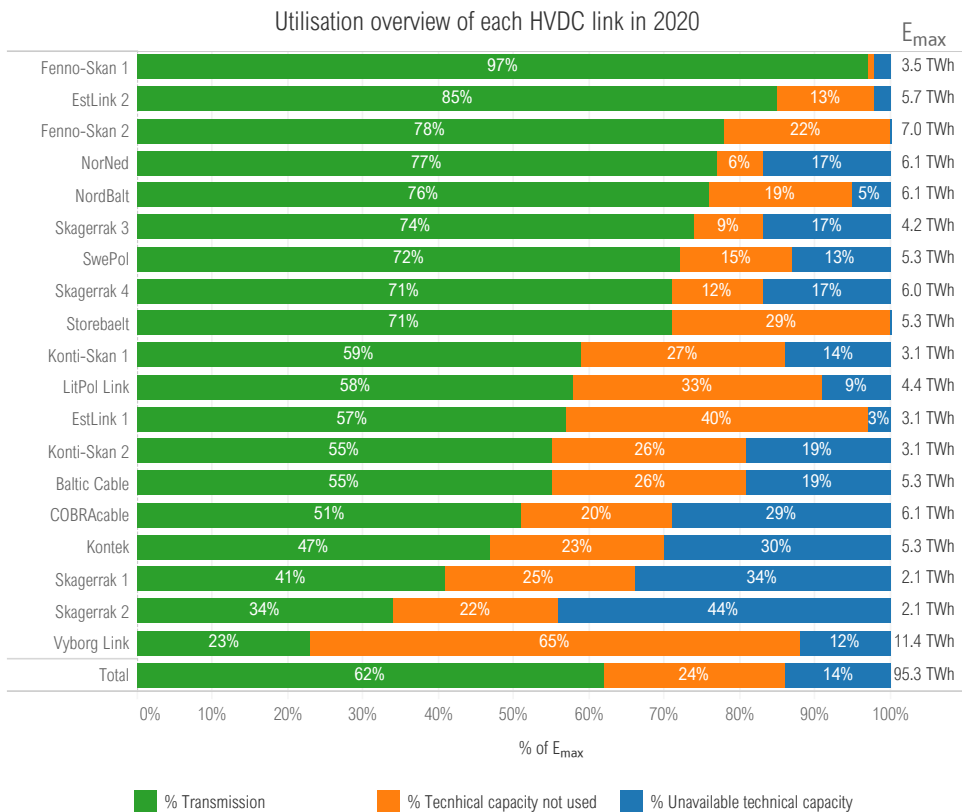

Figure D.2: Overview of each HVDC link sorted by descending transmission (E_T) in 2020.

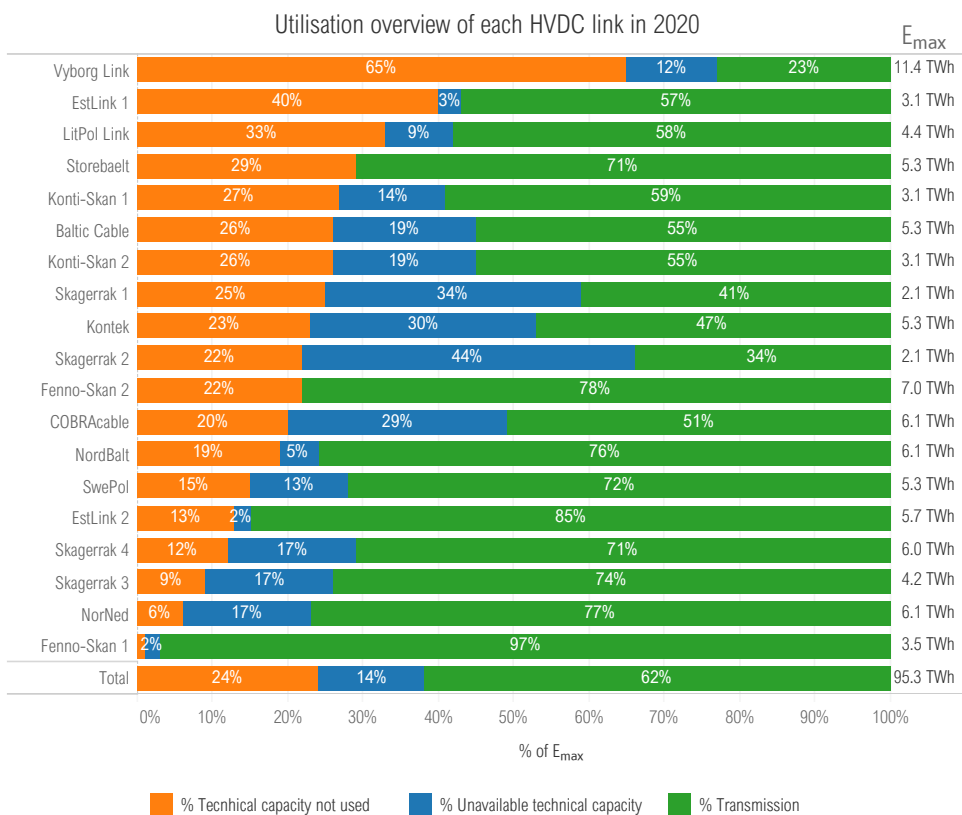

Figure D.3: Overview of each HVDC link sorted by descending technical capacity not used (E_{TCNU}) in 2020.

E Additional figures

This appendix was introduced to allow experimenting with new kinds of figures without affecting the rest of the report. Furthermore, it shows what kind of statistical data can be derived from the data collected by the DISTAC group.

E.1 Annual utilisation per type of HVDC converter

Figure E.1 presents the annual utilisation of all HVDC links using line-commutated converters (LCC) and Figure E.2 all HVDC links using voltage-source converters (VSC).

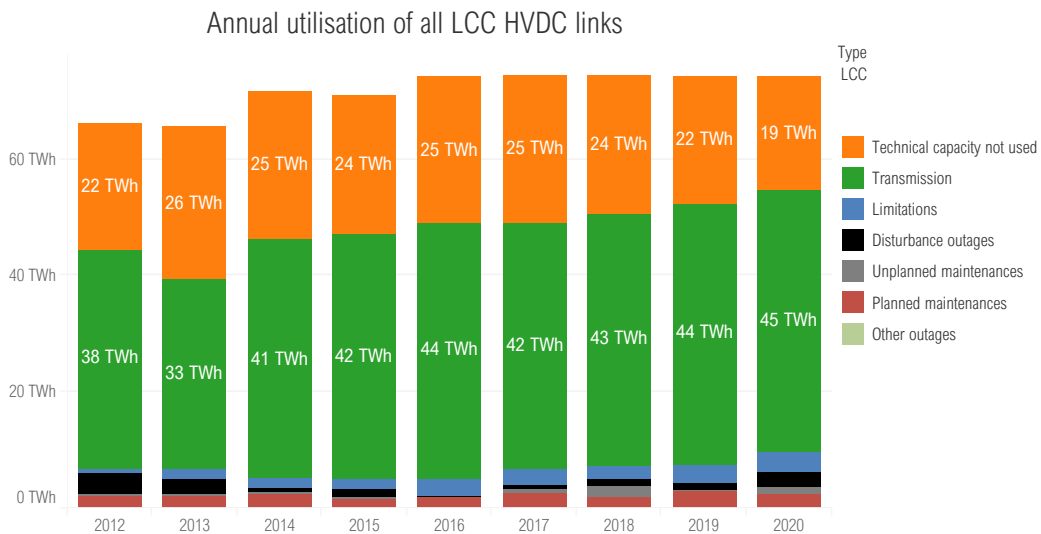

Figure E.1: Annual utilisation of all HVDC links using line-commutated converters (LCC) together presented in megawatt hours (MWh).

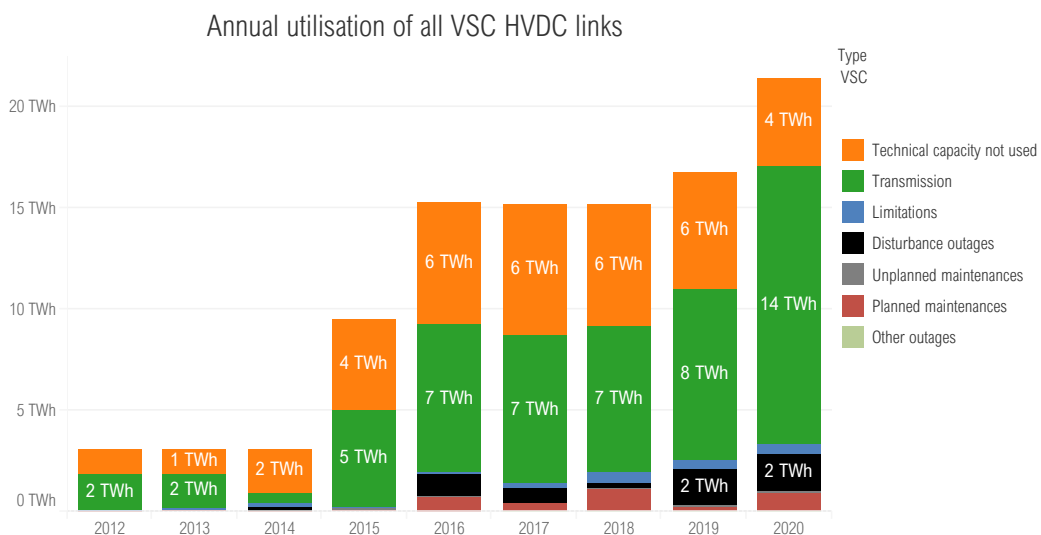

Figure E.2: Annual utilisation of all HVDC links using voltage-source converters (VSC) together presented in megawatt hours (MWh).

E.2 Additional figures with percentages of hours unavailable

This section presents additional figures with a more detailed categorisation of unavailability. The figures presenting the percentage of hours unavailable may be interesting when one considers how often any size of unavailability is affecting an HVDC link.

Figure E.3 presents the percentage of hours all the Nordic and Baltic HVDC links have been affected by a limitation due to seasonal causes during a year. Figure E.4 presents the percentage of hours all the Nordic and Baltic HVDC links have been limited, distributed per origin and type of limitation. The limitation origins are AC and DC limiting conditions,

and the types are AC limiting and DC limiting. Figure E.5 presents the percentage of hours each HVDC link has been limited during 2020, grouped by limitation origin and type. Figure E.6 presents the percentage of hours the HVDC connection between each bidding zone has been limited during 2020, grouped by limitation origin and type.

Figure E.7 presents the percentage of hours each HVDC link has been available due to planned maintenance, distributed per cause, during 2020 and the annual percentage values for all HVDC links combined.

Percentage of hours limited due to seasonal causes, all HVDC links

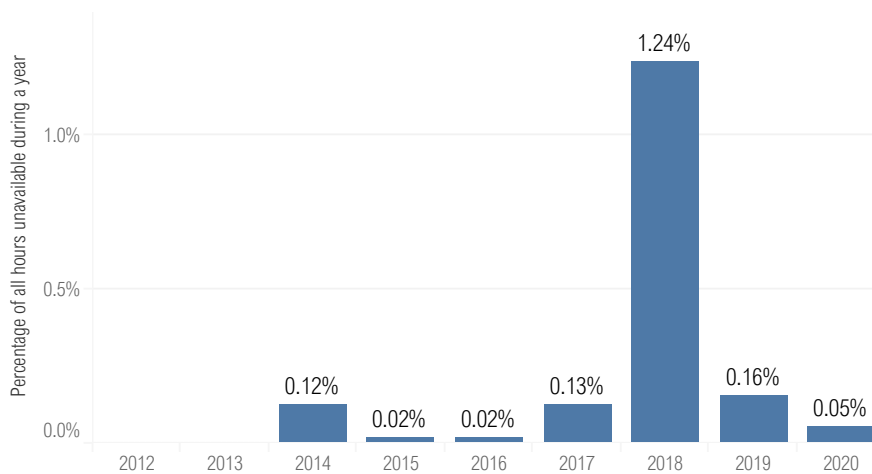

Figure E.3: Percentage of hours all HVDC links have been affected by a limitation due to seasonal causes. The percentage is calculated by counting the number of hours with a limitation due to a seasonal cause and dividing it by the total number of hours in a year.

Percentage of hours limited per limitation origin and type, all HVDC links

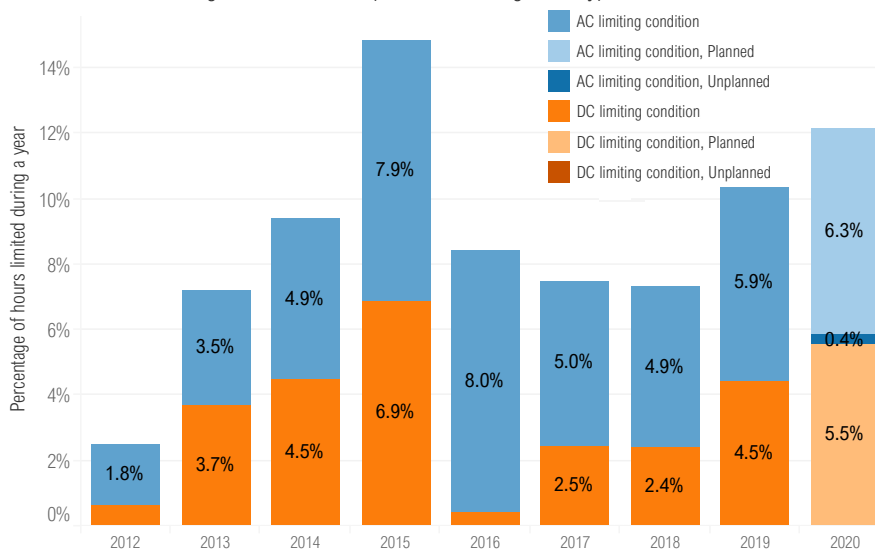

Figure E.4: Annual percentage of hours all HVDC links have been affected by a limitation, grouped by limitation origin and type. The limitation origins are AC limiting and DC limiting and the types are planned and unplanned. The percentage is calculated by counting the number of hours with the specific limitation origin and type and dividing it by the total number of hours in a year. Note, that whether a limitation was planned or unplanned was not recorded prior to 2020.

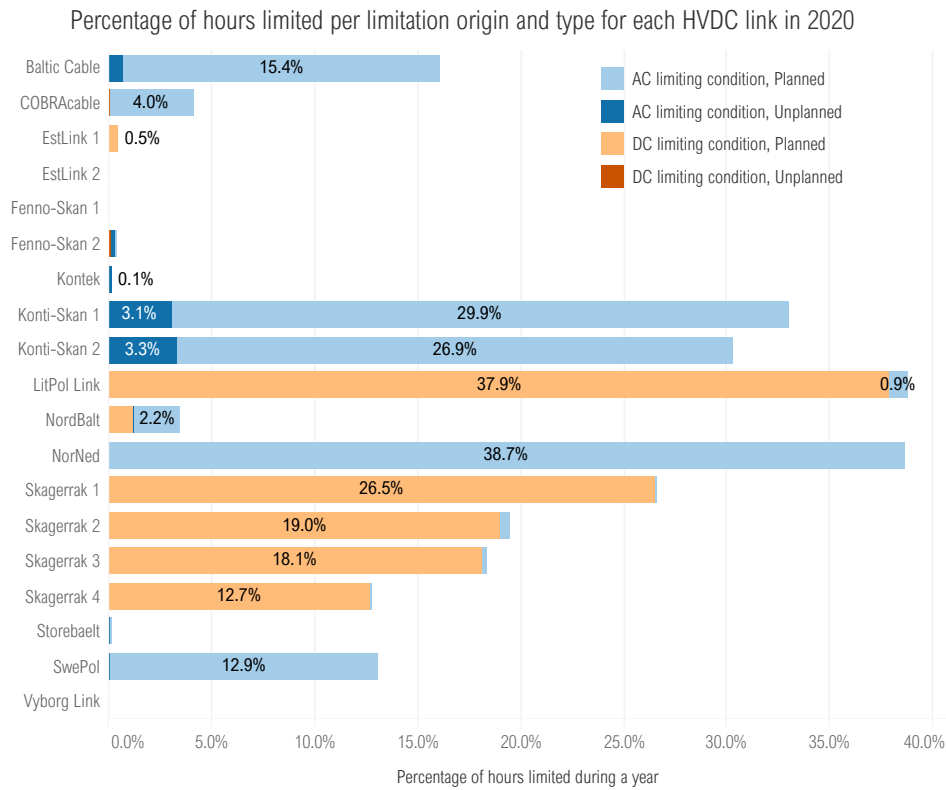

Figure E.5: Percentage of hours each HVDC link has been limited in 2020, grouped by limitation origin and type. The percentage is calculated by counting the number of hours with the specific limitation origin and type and dividing it by the total number of hours in a year.

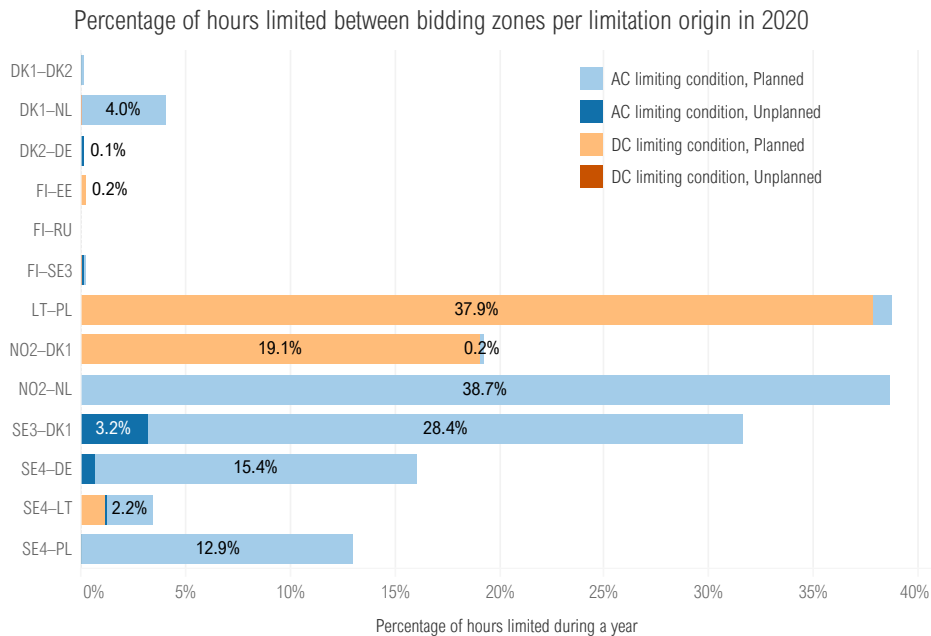

Figure E.6: Percentage of hours the connection between each bidding zone has been limited in 2020, grouped by limitation origin and type. The percentage is calculated by counting the number of hours with the specific limitation origin and type and dividing it by the total number of hours in a year.

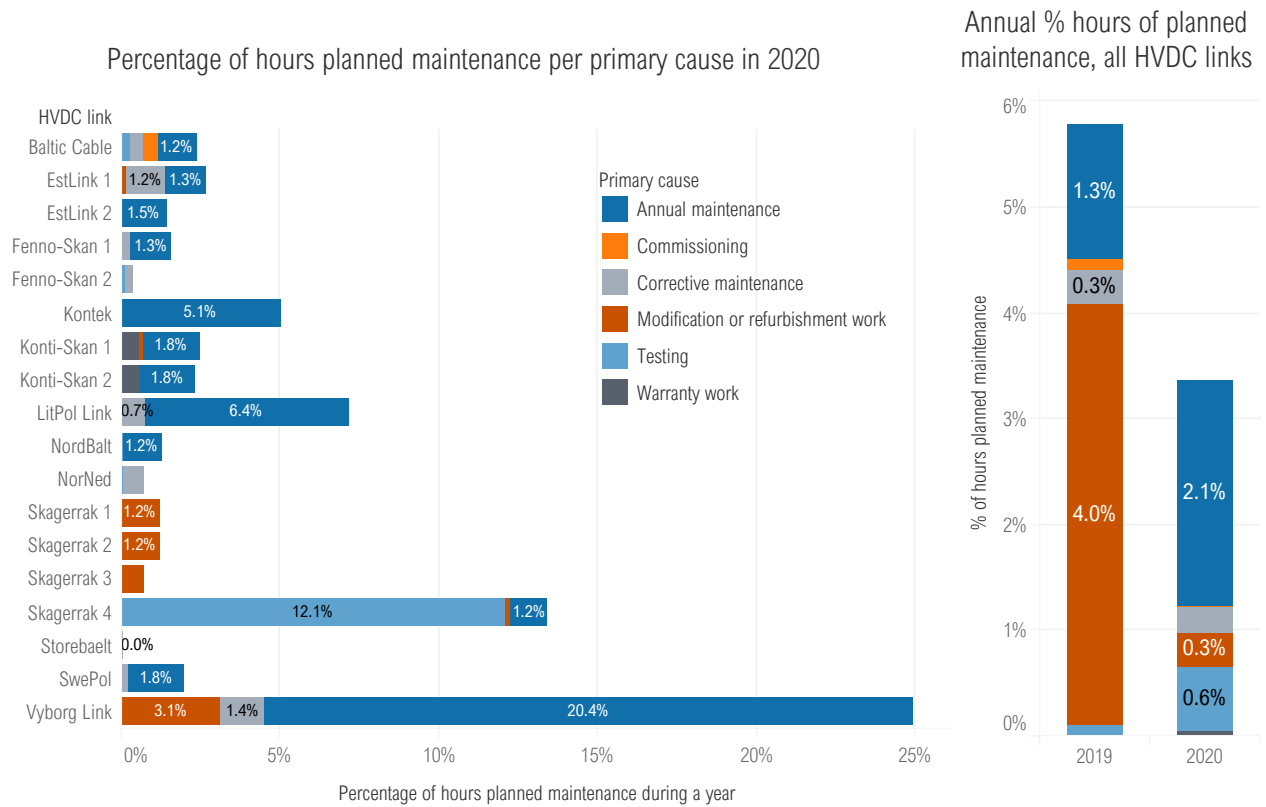

Figure E.7: On the left: percentage of hours each HVDC link has been unavailable due to planned maintenance, distributed per cause, in 2020. On the right: annual percentage of hours all HVDC has been unavailable due to planned maintenance, distributed per cause. The percentage is calculated by counting the number of hours with a planned maintenance and dividing it by the total number of hours in a year.

E.3 Additional figures with origin of event

This section presents additional figures about disturbance and maintenance outages, with a focus on their origin of the event.

Origin of event means from which part of the HVDC link, for example, a fault causing a disturbance outage originated from. A detailed list of the origin categories and subcategories is presented in Appendix B. The schematics in Appendix A can be helpful in visualising the different categories.

Figure E.8 presents the annual average number of disturbances per each HVDC link, grouped by origin. Figure E.9 presents the annual total unavailable capacity due to distur-

bance outages for all HVDC links, grouped by origin. Last, Table E.1 presents the numerical values behind Figure E.9 along with the subcategory of the origin.

Figure E.10 presents the annual total unavailable capacity due to maintenance outages, grouped per primary cause. Figure E.11 presents the annual total unavailable capacity due to corrective maintenances for all HVDC links, grouped by origin, as well as the annual average number of corrective maintenances per each HVDC link, also grouped by origin. The primary cause “corrective maintenance” has not been recorder prior to the year 2019.

Average annual number of disturbance outages for all HVDC links, grouped by origin of event

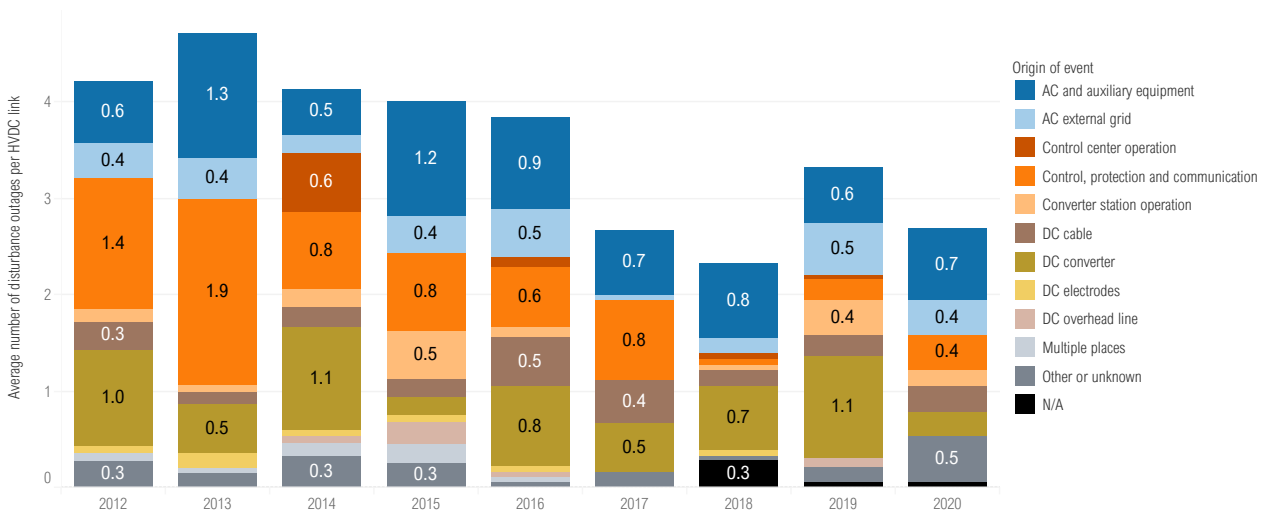

Figure E.8: Average annual number of disturbance outages for all HVDC links, grouped by origin of event.

Annual unavailable capacity due to disturbance outages per origin of event

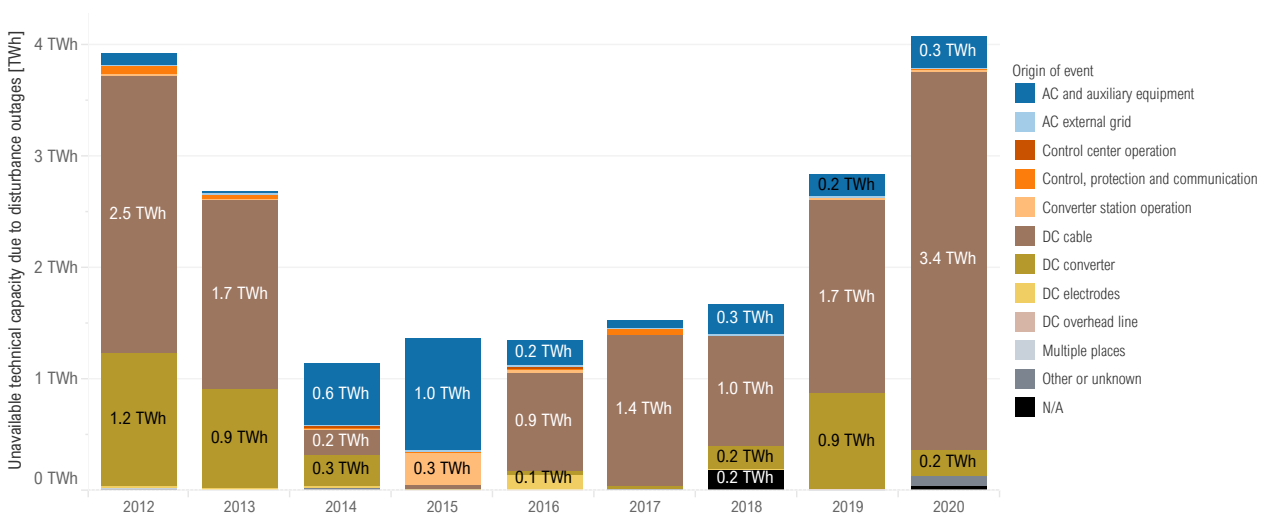

Figure E.9: Annual unavailable capacity due to disturbances outages for all HVDC links, distributed by origin of event.

Table E.1: Annual unavailable capacity due to disturbances outages for all HVDC links, distributed by origin of event. N/A means not available. Note, that the level of detail in the data collection has increased since 2019.

Origin	Subcategory	GWh								
		2012	2013	2014	2015	2016	2017	2018	2019	2020
AC and auxiliary equipment	AC-E.AX - Auxiliary Equipment and Auxiliary Power	-	-	-	-	-	-	-	1.5	280.1
	AC-E.CP - AC Control and Protection	-	-	-	-	-	-	-	15.0	3.6
	AC-E.F - AC Filter and Shunt Bank	-	-	-	-	-	-	-	0.1	0.6
	AC-E.SW - Other AC Switchyard Equipment	-	-	-	-	-	-	-	0.2	1.1
	AC-E.TX - Converter Transformer	-	-	-	-	-	-	-	168.7	0.2
	N/A	93.9	13.5	556.5	1005.9	228.9	65.2	260.5	0.8	1.3
AC external grid	EXT - External AC System	-	-	-	-	-	-	-	8.0	9.2
	N/A	11.4	10.4	1.9	6.2	13.6	0.5	2.2	-	-
Control center operation	N/A	-	-	5.1	-	9.6	-	0.2	0.0	-
Control, protection and communication	C-P.L - Local HVDC Control & Protection	-	-	-	-	-	-	-	6.8	10.3
	C-P.M - Master HVDC Control & Protection	-	-	-	-	-	-	-	-	6.6
	C-P.T - Control & Protection and Telecommunication	-	-	-	-	-	-	-	-	0.7
	N/A	79.8	38.3	23.1	12.6	26.3	63.5	0.6	2.7	-
Converter station operation	C-P.L - Local HVDC Control & Protection	-	-	-	-	-	-	-	21.1	0.8
	C-P.M - Master HVDC Control & Protection	-	-	-	-	-	-	-	8.2	0.6
	N/A	0.4	5.9	2.3	290.4	20.1	-	1.5	-	-
DC cable	TL-C - DC Underground / submarine Cable	-	-	-	-	-	-	-	1729.1	3410.9
	N/A	2505.5	1704.1	226.9	32.2	876.0	1361.8	996.5	-	-
DC converter	DC-E.ME - DC Measuring Equipment	-	-	-	-	-	-	-	65.2	3.6
	DC-E.O - Other DC Yard and Valve Hall Equipment	-	-	-	-	-	-	-	2.8	-
	DC-E.SR - DC Smoothing Reactor	-	-	-	-	-	-	-	245.3	174.5
	V.C - valve capacitor	-	-	-	-	-	-	-	36.5	-
	V.E - Valve Electrical	-	-	-	-	-	-	-	36.9	33.6
	V.VC - Valve Cooling	-	-	-	-	-	-	-	52.8	13.5
	N/A	1192.2	888.1	283.0	3.3	37.2	33.8	210.6	424.4	-
DC electrodes	N/A	3.2	18.4	6.8	9.0	136.3	-	4.6	-	-
	TL-OH - DC Overhead Transmission Line	-	-	-	-	-	-	-	3.1	-
DC overhead line	N/A	-	-	0.6	3.0	2.3	-	-	-	-
	N/A	24.3	2.1	0.2	0.2	0.7	-	-	-	-
Multiple places	N/A	-	-	-	-	-	-	186.5	0.7	42.8
Other or unknown	O - Other	-	-	-	-	-	-	-	0.0	4.5
	N/A	13.2	0.9	34.5	1.4	0.7	8.4	0.7	3.1	83.1

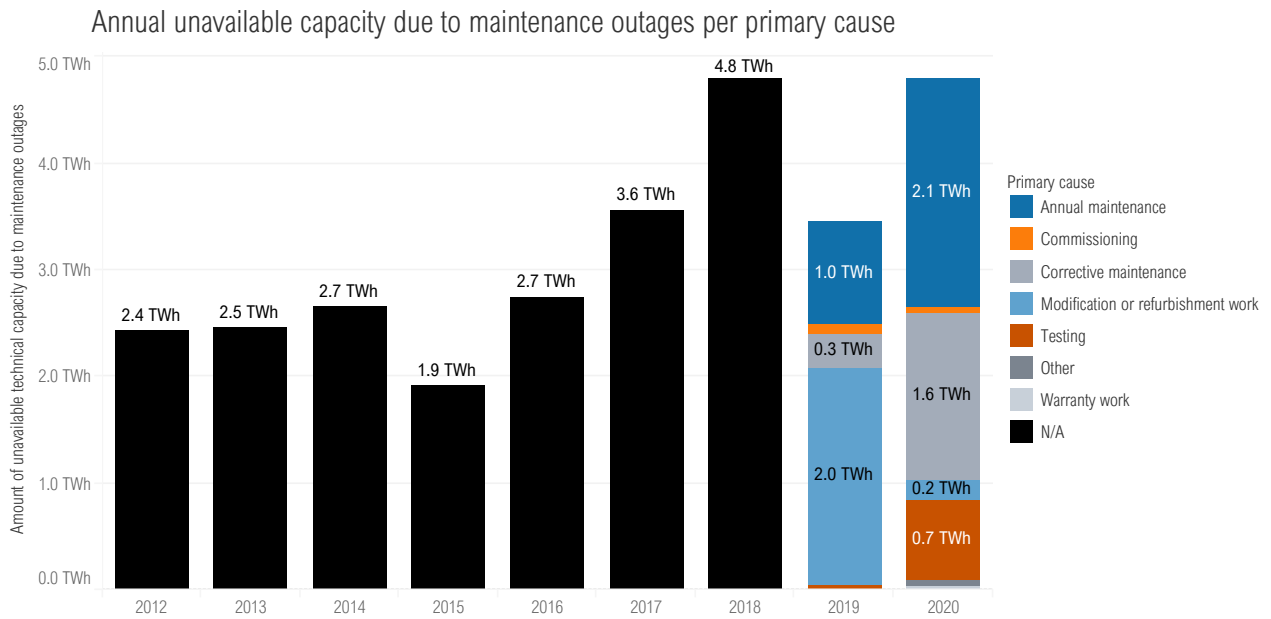

Figure E.10: Annual unavailable capacity due to maintenance outages for all HVDC links, distributed by primary cause. Note, that primary cause has not been recorded prior to 2019.

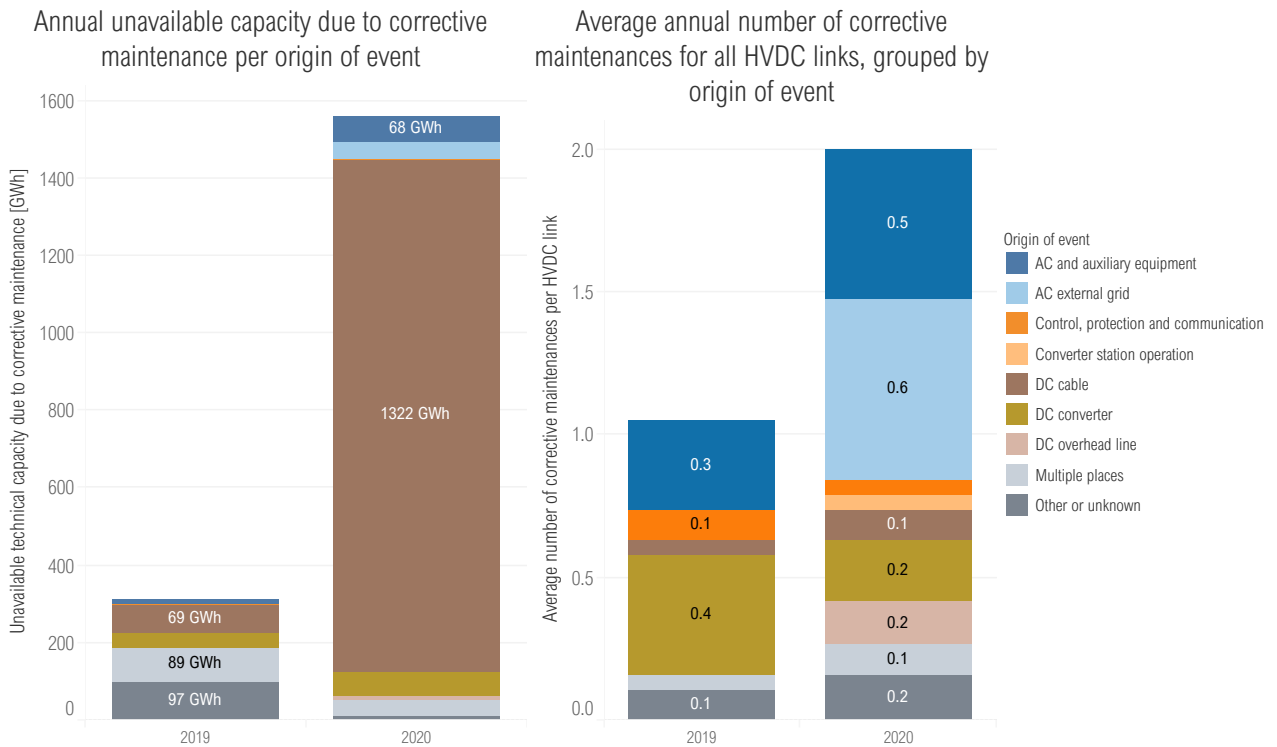

Figure E.11: On the left: annual unavailable capacity due to corrective maintenance outages for all HVDC links, distributed by origin of event. On the right: average annual number of corrective maintenance outages for all HVDC links, grouped by origin of event. The primary cause “corrective maintenance” has not been recorder prior to the year 2019.

This page is intentionally left blank.



European Network of
Transmission System Operators
for Electricity